

How to upgrade GL860 firmware

A. Notes

- ♣ This manual explains the upgrade method of GL860 firmware.
- ♣ This firmware is only for customers using the GL860. Please note that it is not available on other models.
- ♣ During the upgrade, DO NOT turn off the GL860. If you do so, the firmware can be corrupted and the GL860 will not start.
- ♣ The SD card is required to upgrade.,
Available type in the slot of SD card for GL860 is SD/SDHC. (SDXC is not available.)
- ♣ Although the setting conditions will remain after upgrading the firmware version, we recommend that you save the setting conditions as a backup.
For instructions on how to save it, refer to“ B. Upgrade procedure ”.
- ♣ The set values in I/F menu (IP address, etc.) may change due to version update.
In advance, save the setting conditions for communications.
For instructions on how to save it, refer to“ B. Upgrade procedure ”.

B. Upgrade procedure

Operation/communication settings are retained when upgrading.

To save the settings manually, please refer to “1. Saving Operation Settings” and “2.

1. Save the setting conditions

(1) Open the “File Menu” by pressing “FILE” key.

(2) Select “Save Settings” of “Save/Load current settings” to display the following screen.

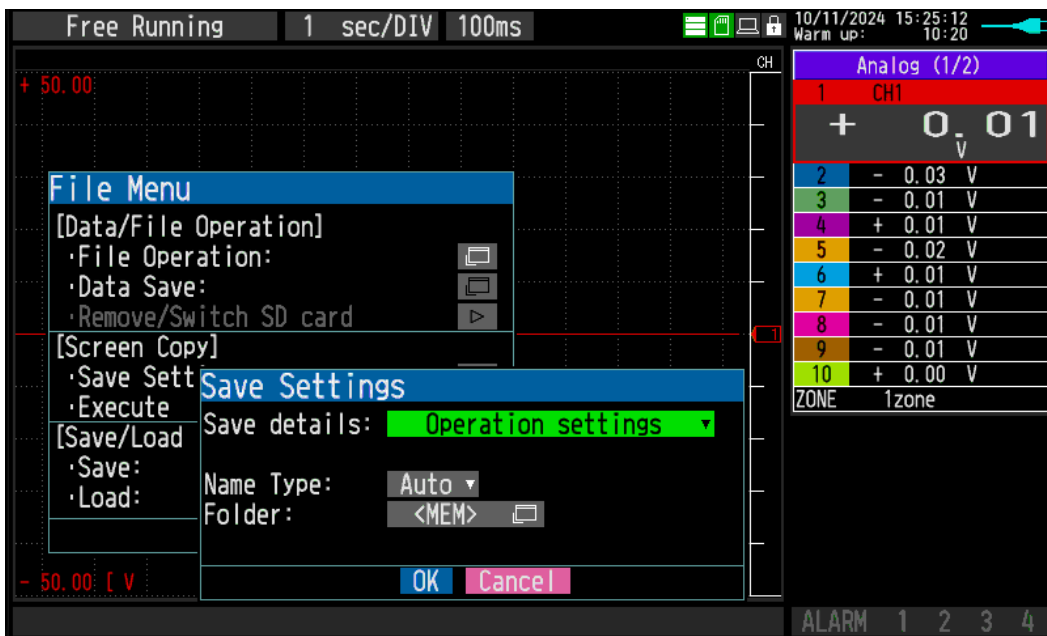

(3) Select "Operation settings" in the “Save details”.

(4) Set “Name Type” and “Folder” as you like and then select “OK”.

- Name Type
 - : Auto → The file name is saved as date and time.
 - : User → Saved in any file name.
 - : SN → Saved in any file name with serial number.
- Folder
 - : <MEM> → Save in the internal memory.
 - : <SD> → Save in the SD card.

2. Save the setting conditions for communications

- (1) Open the “File Menu” by pressing “FILE” key.
- (2) Select “Save Settings” of “Save/Load current settings” to display the following screen.

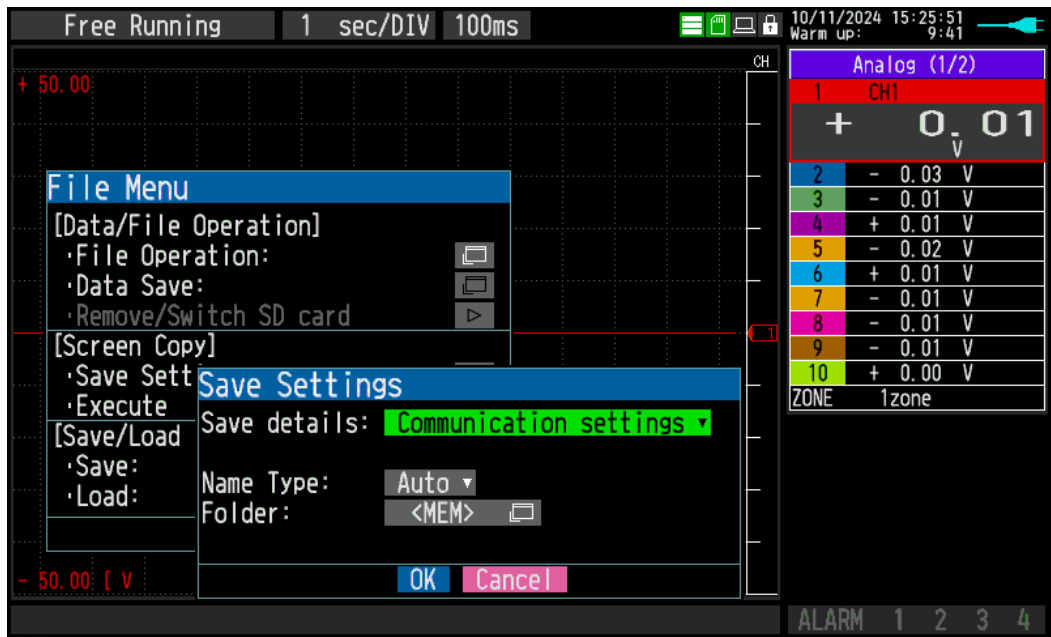

- (3) Select "Communication settings" in the “Save Settings”.
- (4) Set “Name Type” and “Folder” as you like and then select “OK”.
 - Name Type
 - : Auto → The file name is saved as date and time.
 - : User → Saved in any file name.
 - : SN → Saved in any file name with serial number.
 - Folder
 - : <MEM> → Save in the internal memory.
 - : <SD> → Save in the SD card.

3. Preparation for version update

Please download the upgrade file from our WEB site.

<https://www.graphteccorp.com/>

(1) Prepare upgrade file.

MainVerxxxRevyyyyAzz.GL860

Version information is shown below.

- xxx:Version information
(Ex.) “ 102 ” indicates “ V1.02 ”.
- yyy:Revision Information
(Ex.) “ 0002 ” indicates “ Rev0002 ”.
- zz:Special item number
(Ex.) “ 00 ” indicates “standard product”

(2) Copy the upgrade file to the root folder in the SD card by using a PC. (Root folder refers to the top folder of the directory.)

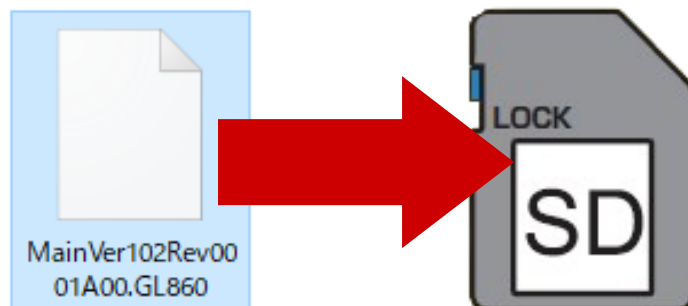

(3) Insert the SD card with the upgrade file to the GL860 while it is turned off.

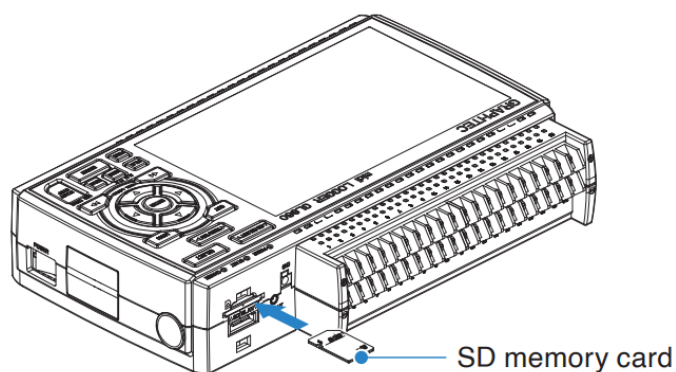

(4) Turn on the GL860.

```
Flash-ROM Update
[Current Information]
MAIN   ROM Version : 1.10
Suffix :
----- Select File -----
UP     : Select Upper File
DOWN   : Select Lower File
ENTER  : Start Update
QUIT   : Exit Update

MainVer102Rev0002A00. GL860

[File Information]
ID : GRAPHTEC GL860 MAIN ROM
Version: 1.10 A00
```

The screen above is displayed. Press “ENTER” key.
Version upgrade is started up. Wait until it is finished.

(5) "Update Completed. Please turn off power." message in yellow is displayed with a beep when it completes.

DO NOT turn off the power until the version upgrade is finished with a beep.

Automatically restart in a few seconds.

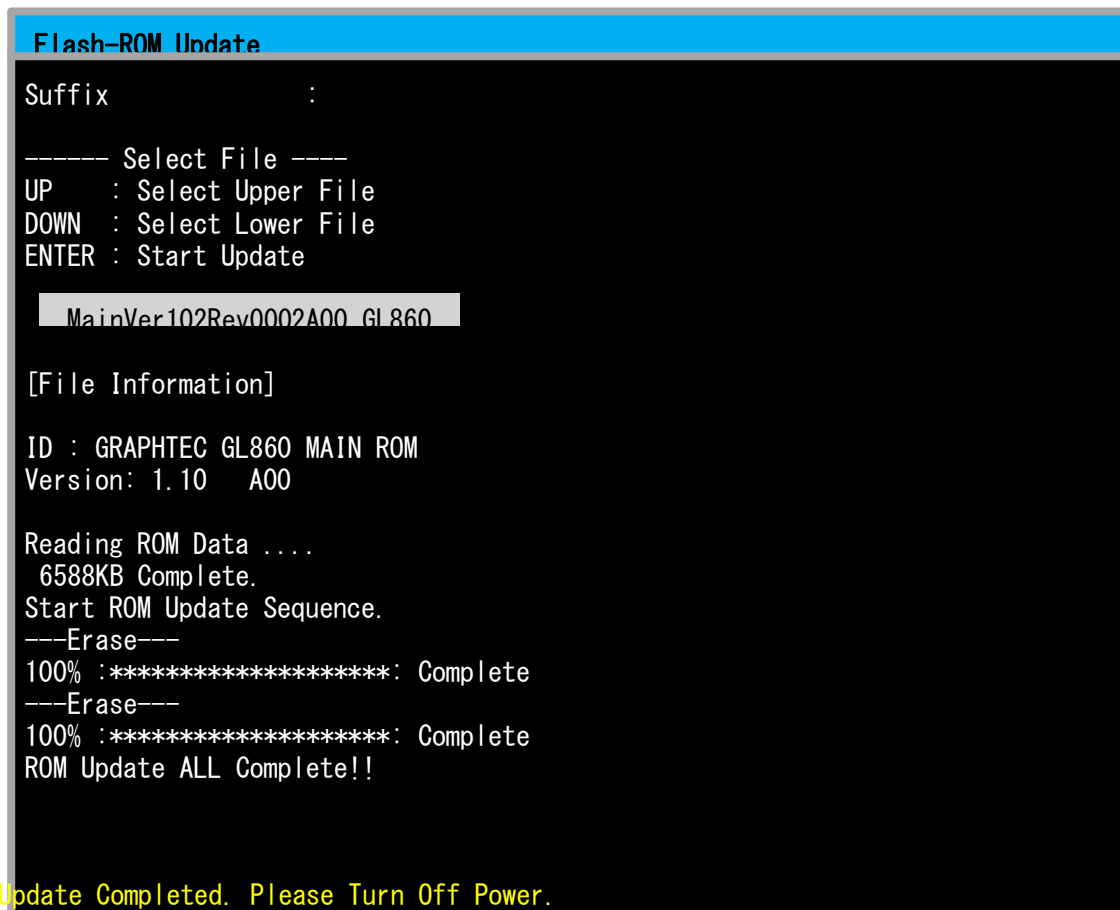

```
Flash-ROM Update
Suffix          :

----- Select File -----
UP   : Select Upper File
DOWN : Select Lower File
ENTER : Start Update

MainVer102Rev0002A00_GL860

[File Information]
ID : GRAPHTEC GL860 MAIN ROM
Version: 1.10  A00

Reading ROM Data ....
6588KB Complete.
Start ROM Update Sequence.
---Erase---
100% :*****: Complete
---Erase---
100% :*****: Complete
ROM Update ALL Complete!!

Update Completed. Please Turn Off Power.
```

(6) After rebooting, a dialog message will appear asking "Do you want to delete the upgrade file?".

Select "Yes" to delete the upgrade file stored in the SD CARD.

GL860 version upgrade is completed.

4. Troubleshooting

The settings before the upgrade are retained, but if you wish to reflect the settings arbitrarily, please do the following.

- (1) Open the "File Menu" by pressing "FILE" key.
- (2) Select "Load Settings" of "Save/Load current settings" to display the following screen.
Then open the setup file saved in Step 1 and select "OK" to apply the settings.
(The extension of file is "CND".)

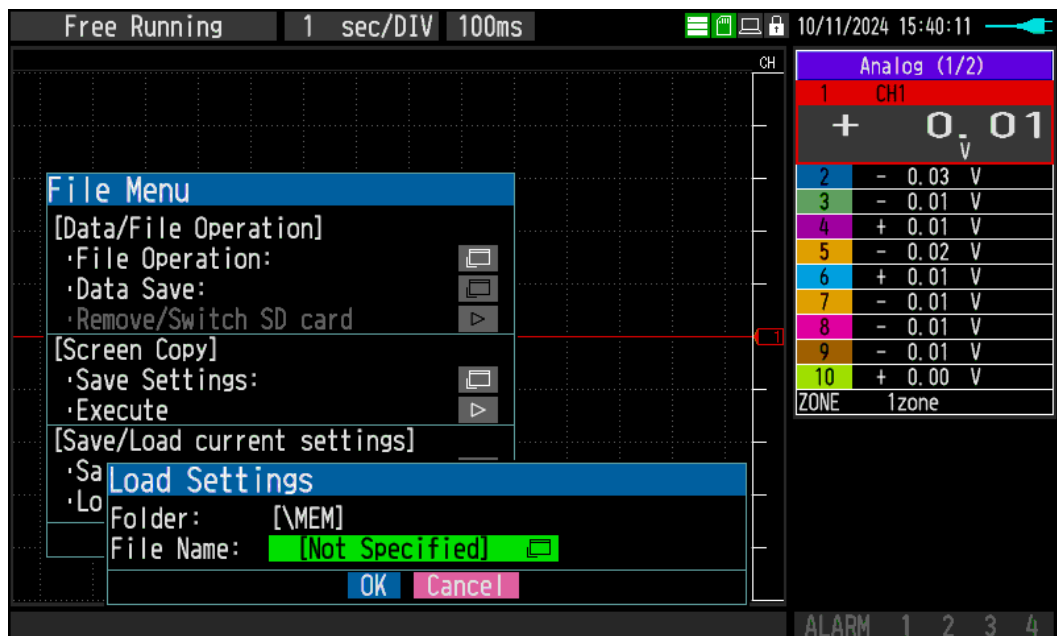

- (3) If the Interface settings have been changed, open the communication setting file saved in step 2 and select "OK" to apply the setting. (The extension of file is "NCD".)