

GL28-APS

Application software

USER' S MANUAL

MANUAL NO. APS(GL28)-UM-153

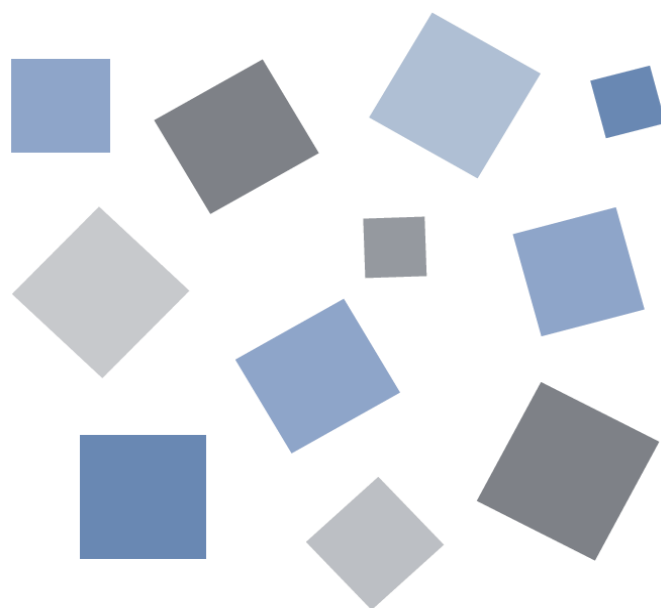

GRAPHTEC

Contents

1. Main Features	4
1-1.A Variety of Display Formats.....	4
1-2.Simple and Easy to Use.....	6
1-3.Multichannel Measurement.....	6
2. System Requirements	7
3. Connecting to a PC (Personal Computer).....	8
3-1.Connecting via USB.....	8
3-2.Connecting via LAN.....	9
3-3.Setting USB ID or IP Address.....	10
3-3-1. USB Settings.....	10
3-3-2. TCP-IP Settings (GL860, GL840).....	11
3-3-3. Example of TCP-IP Settings.....	11
3-4.Set wireless LAN of GL260, GL860, GL240 and 840.....	12
4. Installing the USB Driver.....	13
4-1.For GL260/GL860/GL240/840.....	13
5. Installing the Application Software.....	14
6. Launching and Exiting the Software.....	15
6-1.Launching the Software.....	15
6-2.Exiting the Software.....	15
7. GL28-APS.....	16
7-1.Basic Operating Procedure.....	16
7-2.Controlling Device.....	16
7-3.Language Setting.....	17
7-4.PC Connection Settings.....	18
7-11.Display Screens.....	20
7-11-1. Y-T (Main Screen).....	21
7-11-2. Digital.....	23
7-11-3. Statistics and History.....	24
7-11-4. Accumulated Graph Display.....	25
7-12.Settings Screens.....	28
7-12-1. AMP Settings.....	28
7-12-2. Data Capture Settings.....	33
7-12-3. Trigger/Alarm Settings.....	35
7-12-4. Report Settings.....	43
7-12-5. Email Settings.....	45
7-12-6. Other Settings.....	46
7-13.FILE menu.....	47
7-13-1. Open File.....	47
7-13-2. File History.....	49
7-13-3. CSV File Batch Conversion.....	50
7-13-4. Print Screen.....	51
7-13-5. Save Screen.....	52

7-13-6. Other Settings	52
7-14.Replay Data	54
7-14-1. Y-T	54
7-14-2. Digital	56
7-14-3. XY	57
7-14-4. Accumulated Graph	58
7-14-5. Superimpose/Link	59
7-14-6. Convert then Save	60
7-14-7. Scaling Settings	61
7-14-8. Other Settings	62
7-14-9. Scale Operations	62
7-14-10. Scroll bar	62
7-15.Other Functions.....	63
7-15-1. Alarm	63
7-15-2. About Icons	64

1. Main Features

This software can control and operate such as setting, capturing, and playing data of GL260, GL860, GL240 and GL840 through USB or LAN connection.

1-1. A Variety of Display Formats

Special features include Y-T display, digital display, statistic and history display on a large easy to read screen.

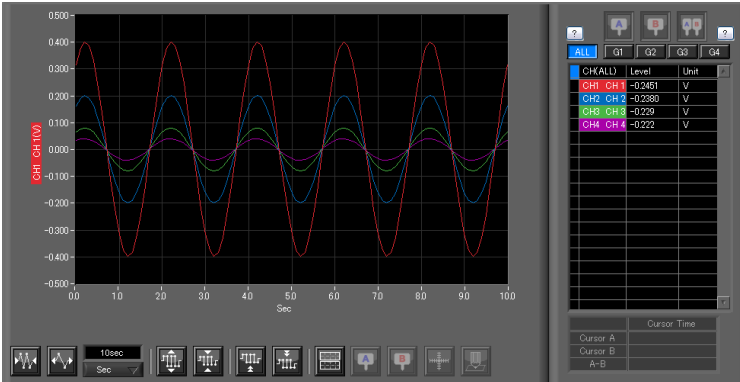

Y-T View

This graph shows data with the input signal levels on the Y-axis and the time on the X-axis. It can display a waveform and digital values of each channel at the same time. The control icons in the lower part of the screen allow you to scale up and down the time axis, X-axis, etc. This graph can be displayed in two or five split screens, each showing different signals.



Digital View

Displays digital values of each channel in a large, easy-to-read numbers.

The Statistics and History Display shows a table of recorded data. The table includes columns for No., Date Time, ms, and channel values (CH1, CH2, CH3, CH4). The data is organized into a grid with a summary section at the bottom.

No.	Date Time	ms	CH1 (mV) CH 1	CH2 (mV) CH 2	CH3 (mV) CH 3	CH4 (mV) CH 4	Alarm1 (1234567890)	AlarmOut (1234)
4	2010-03-01 15:30:39	543	-0.0014	-0.01	-0.01	-0.01	LLLLLLLLLL	LLLL
5	2010-03-01 15:30:40	543	-0.0014	-0.01	-0.01	-0.01	LLLLLLLLLL	LLLL
6	2010-03-01 15:30:41	543	-0.0016	-0.01	-0.01	-0.01	LLLLLLLLLL	LLLL
7	2010-03-01 15:30:42	543	-0.0014	-0.01	-0.01	-0.01	LLLLLLLLLL	LLLL
8	2010-03-01 15:30:43	543	-0.0014	-0.01	-0.01	-0.01	LLLLLLLLLL	LLLL
9	2010-03-01 15:30:44	543	-0.0014	-0.01	-0.01	-0.01	LLLLLLLLLL	LLLL
10	2010-03-01 15:30:45	543	-0.0013	-0.01	-0.01	-0.01	LLLLLLLLLL	LLLL
11	2010-03-01 15:30:46	543	-0.0013	-0.01	-0.01	-0.01	LLLLLLLLLL	LLLL
12	2010-03-01 15:30:47	543	-0.0014	-0.01	-0.01	-0.01	LLLLLLLLLL	LLLL
13	2010-03-01 15:30:48	543	-0.0013	-0.01	-0.01	-0.01	LLLLLLLLLL	LLLL
14	2010-03-01 15:30:49	543	-0.0014	-0.01	-0.01	-0.01	LLLLLLLLLL	LLLL
15	2010-03-01 15:30:50	543	-0.0013	-0.01	-0.01	-0.01	LLLLLLLLLL	LLLL
16	2010-03-01 15:30:51	543	-0.0014	-0.01	-0.01	-0.01	LLLLLLLLLL	LLLL
17	2010-03-01 15:30:52	543	-0.0013	-0.01	-0.01	-0.01	LLLLLLLLLL	LLLL
18	2010-03-01 15:30:53	543	-0.0014	-0.01	-0.01	-0.01	LLLLLLLLLL	LLLL
19	2010-03-01 15:30:54	543	-0.0014	-0.01	-0.01	-0.01	LLLLLLLLLL	LLLL

	CH1 (V) CH 1	CH2 (V) CH 2	CH3 (V) CH 3	CH4 (V) CH 4
Average	-0.0014	-0.01	-0.01	-0.01
Max	-0.0013	-0.01	-0.01	-0.01
Min	-0.0016	-0.01	-0.01	-0.01

Statistics and History Display

Maximum, minimum and average values can be confirmed during recording. Alarm operation can be displayed as a list in time sequence for your confirmation.

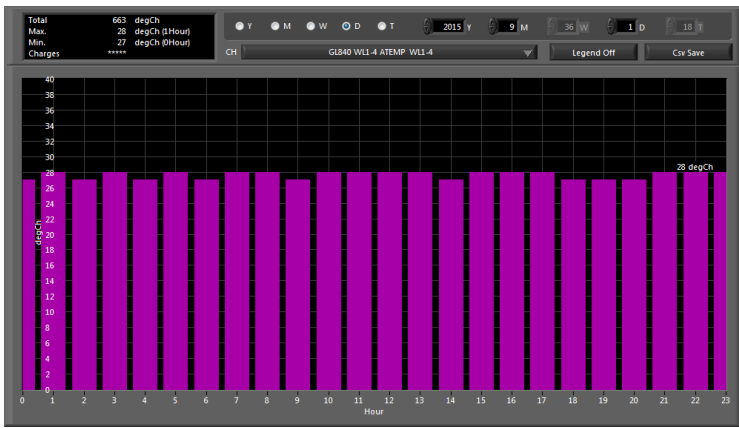

Accumulated Graph Display

Accumulated data collected with sensors which can be connected to GL240 or 840 (temperature and humidity sensor (GS-TH), luminance and UV ray sensor (GS-LXUV), power sensor (DPA-AC)) can be displayed using bar graphs. The data can be confirmed for each period of a year, month, week, day, or hour. The power charges can also be displayed for the accumulated power.

1-2. Simple and Easy to Use

Large icons make it simple and easy to control the waveforms. Time axes, spans, waveform positions can be changed easily. Also, you can maximize a window to fit the screen.

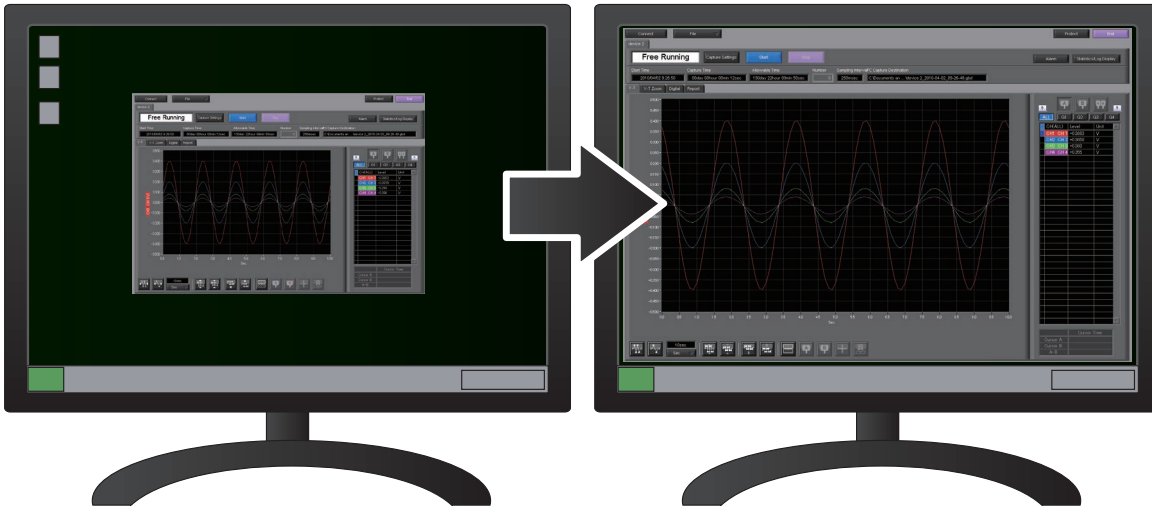

1-3. Multichannel Measurement

Can measure a maximum of 10 units. Since a maximum of 4 can be recorded as a group in each device, the recording start-up and stopping of each group can be synchronized.

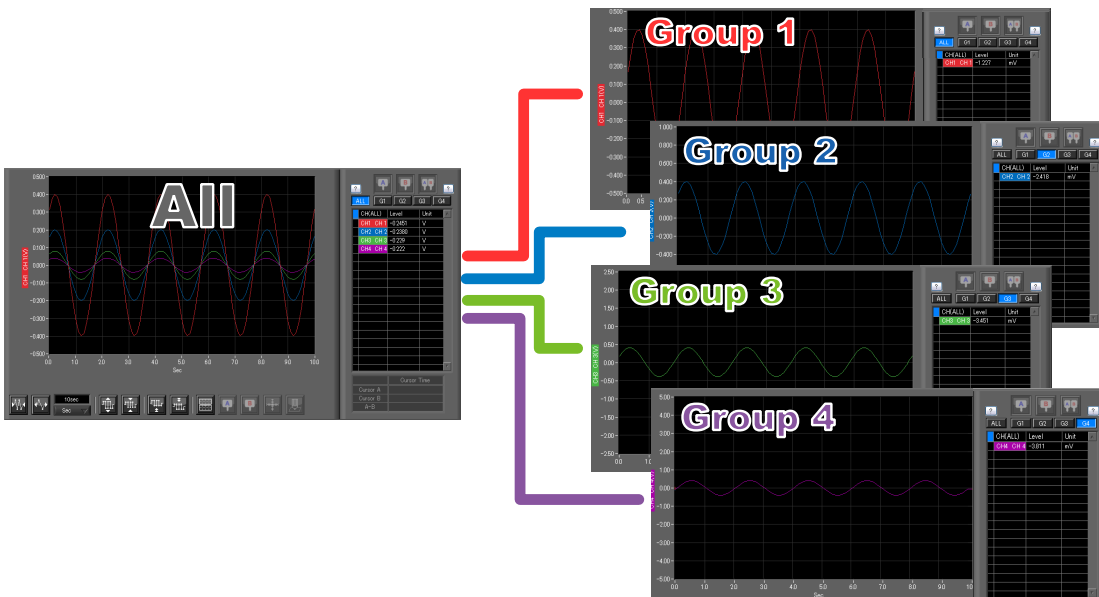

2. System Requirements

Make sure that the computer on which you plan to install the software meets the following requirements.

Item	System requirements
OS	Windows 11 (64bit) * Meet system requirements of the OS * Please use a PC that meets the system requirements.
CPU	Intel Core 2 Duo or more is recommended.
Memory	4GB or more is recommended.
HDD	32 GB or more free space is recommended.
Display	1024 x 768 resolution or higher, 65535 colors or more (16-bit or more)
Other	USB port, TCP-IP port, Microsoft Excel software (for the Export to Direct Excel File and Display in Excel functions)

● CHECKPOINT

- Even when using a PC that meets the system requirements, measurement data may not be captured correctly depending on the PC status (e.g. running other applications or insufficient memory capacity in the storage media used). Exit all other applications before capturing data to the internal hard disk.
- While you are using this software, do not activate any other software. Whenever possible, avoid manipulations or processing of other software than this one (e.g., screen saver, virus check, file copy and transfer, and file search processing, etc.).
- If a communication error occurs during real-time recording to PC, data may be lost. In that case, please acquire the data saved on the GL main body side. In addition, please improve the communication environment.

3. Connecting to a PC (Personal Computer)

3-1. Connecting via USB

The GL is connected to a PC via a USB cable.

For GL860 or GL840

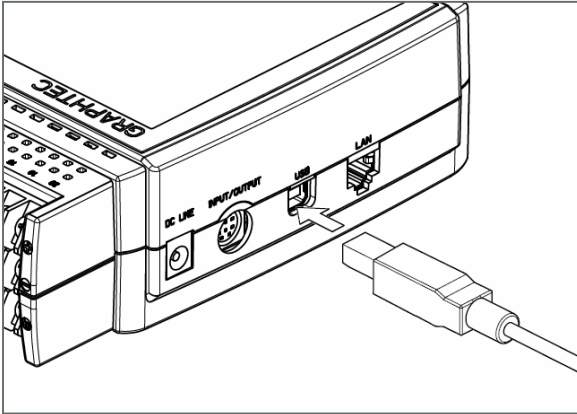

For GL260 or GL240

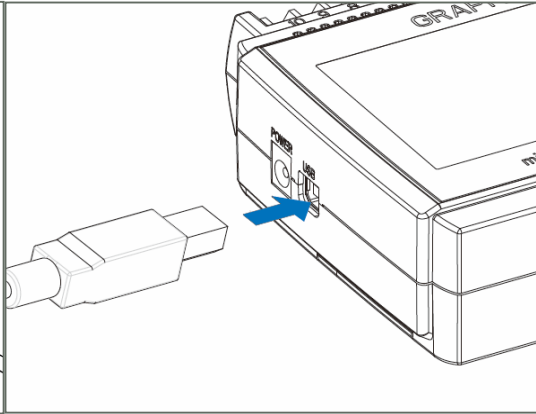

● CHECKPOINT

- When using a USB cable, a USB driver must be installed in the PC. Refer to the "USB Driver Installation Manual" for the installation procedure.
- LAN connector. Make sure the cable is inserted into the correct connector.

Use an A-B type USB cable to connect the GL to a PC.

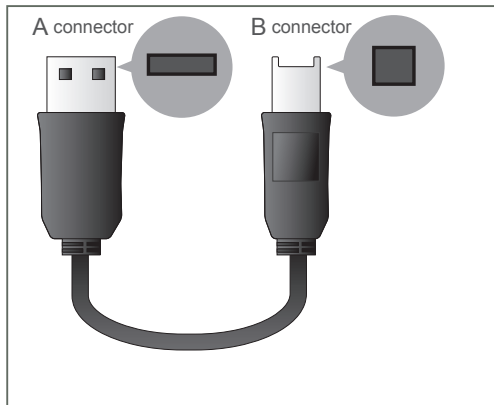

3-2. Connecting via LAN

It can also be connected via a LAN cable. (only for the GL860 and GL840)

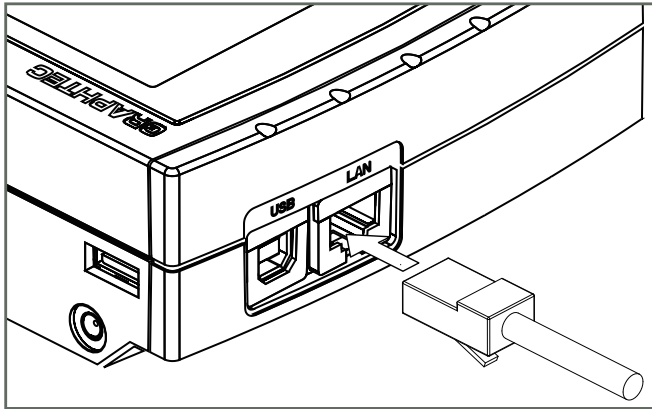

Depending on your usage, use one of the following types of LAN cables.

•LAN Cable Types

Use a crossing cable when connecting directly to a PC, without using a hub.



Use a straight cable to connect to a PC through a hub.

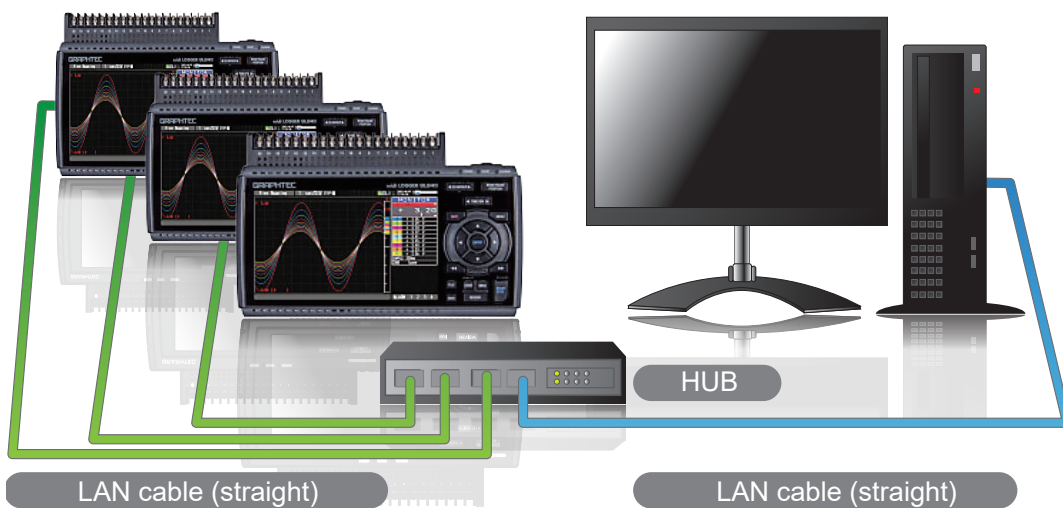

3-3. Setting USB ID or IP Address

To connect to a PC, configure the device's interface settings.

3-3-1. USB Settings

For GL260: Press the MENU key four times to open "I/F Settings". Input the "USB ID".



For GL240: Press the MENU key four times to open "OTHR Settings". Input the "USB ID".

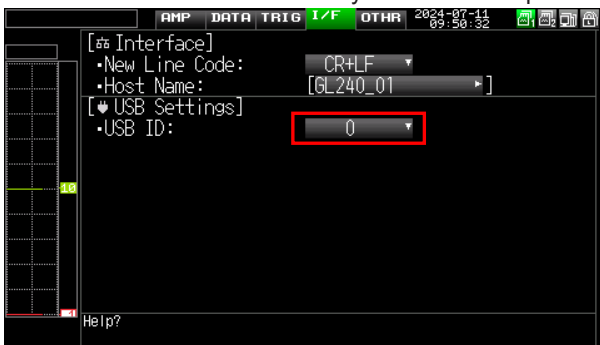

For GL860: Press the MENU key five times to open "I/F Settings". Input the "USB ID".

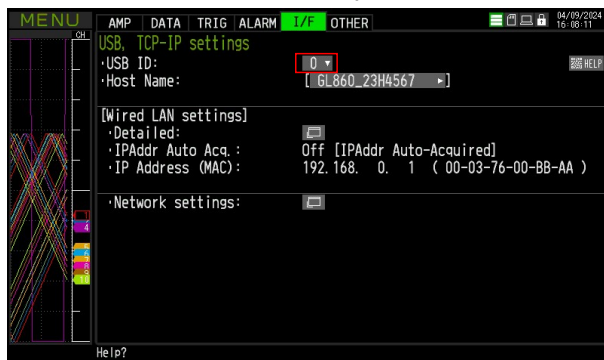

For GL840: Press the MENU key four times to open "I/F Settings". Input the "USB ID".

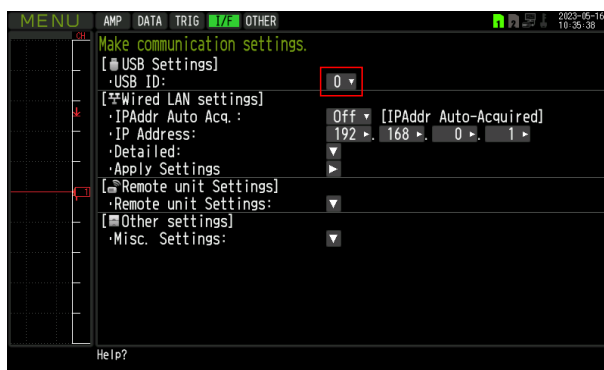

● CHECKPOINT

After changing the USB ID setting of this unit, turn off and on the power of this unit.

3-3-2. TCP-IP Settings (GL860, GL840)

Press the [MENU] key five times to open the [I/F] menu.
Set the [IP Address], [Subnet Mask], [Port Number], [DNS Address]
and select [Reflect Settings] to accept the changes.

- Using Auto IP Address Acquisition

If there is a DHCP server in the same segment of the connected network, Auto IP Address Acquisition is available.

Refer to User's Manual for details.

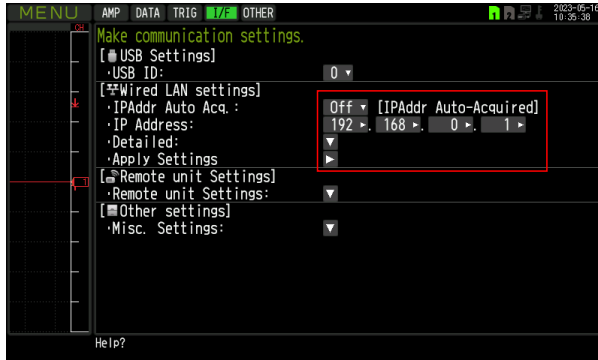

3-3-3. Example of TCP-IP Settings

Connecting one PC and one GL860/GL840

Refer to the following settings if you are not connecting to a corporate LAN or other networks.

Connect GL860/GL840 to a PC with a crossover cable.

PC's IP Address	192.168.1.1
GL860/GL840's IP Address	192.168.1.2

● CHECKPOINT

- In this case, always set the subnet mask to "255.255.255.0".
- In this case, always set the port number to "8023".

3-3-3-1. Setting PC's IP Address

[Control Panel] → [Network and Sharing Center] → [Local Area Connection] → [Properties]
[Select Internet Protocol (TCP/IP)] → [Properties] → Check "Use the following IP Address" →
Set [IP Address] and [Subnet Mask] → [OK]

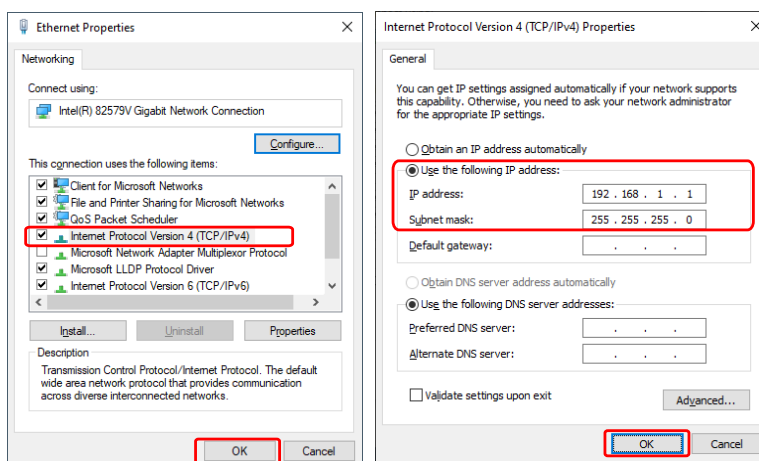

3-4. Set wireless LAN of GL260, GL860, GL240 and 840

Wireless LAN function is only covered for models GL260, GL860, GL240 and GL840 when the wireless LAN option is equipped.

Refer to each device's User Manual for details of wireless LAN setting of GL260, GL860, GL240 and GL840.

4. Installing the USB Driver

4-1. For GL260/GL860/GL240/840

To connect this unit to a PC with the USB interface, a USB driver must be installed in the PC. USB driver and USB driver manual are stored in the unit.

5. Installing the Application Software

This chapter describes how to install the application software.

1. Transfer the GL28-APS installer in the file stored in the main unit to your PC using USB drive mode.
Or, download the latest version of APS from the GRAPHTEC IWATSU Test Instruments website and extract the compressed file. Start "Setup_Japanese.exe" in the folder.
2. Follow the instructions on the screen to continue with the installation.
3. When a message to restart your PC appears after the installation, be sure to restart it and then start this software.

● CHECKPOINT

Be sure to observe the following points when connecting the GL to a PC.

- Do not connect any devices apart from a mouse or a keyboard to any of the other USB terminals on your PC.
 - Set the PC's power-saving functions to Off.
 - Set the Screen Saver to Off.
 - Set the anti-virus software auto update and scan scheduler functions to Off. Also, set the Windows auto update and scheduler functions to Off.
 - When using the note PC, if you close the display, the PC may be in stand-by mode. Please do not close the display during using the software.
-

Trademarks

- Windows, Windows Vista and Windows 7 are registered trademarks of Microsoft Corporation in the US and other countries.
 - The company names, logos and product names mentioned herein are the trademarks or registered trademarks of their respective companies.
-

6. Launching and Exiting the Software

6-1. Launching the Software

Click the Taskbar's "Start" button → "Programs" → "Graphtec" → "GL28-APS" to launch the application software. Once the program has started up, the following screen is displayed.

With the first activation, selection of the language will be performed.

-
- CHECKPOINT
It will take some time to start up.
-

6-2. Exiting the Software

To exit the software, click the "End" button in the upper right corner of the main screen.

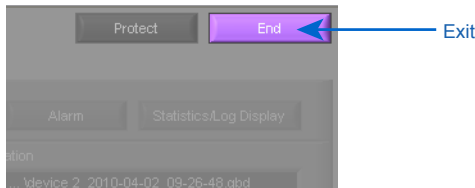

When you try to exit the software in the connected status, a message appears to confirm if the setting conditions are saved to the device.

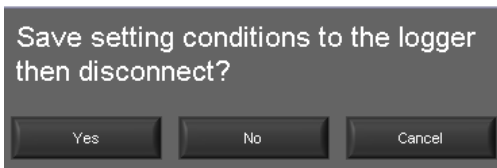

Operation	Description
Yes	Click this button to save the setting conditions on this software in the GL device and exit. Next time connecting to the device, the last setting conditions are reflected.
No	Click this button to exit without saving the setting conditions on this software in the GL device. After the power is turned on, the setting conditions on GL device returns to the state before connecting to the software.
Cancel	This software is not disconnected and it remains active.

-
- CHECKPOINT
The following settings are not saved to this unit.
 - Setting items not available on the GL unit
 - Line color settings
-

7. GL28-APS

7-1. Basic Operating Procedure

The basic operating procedure of this software consists of the following four operations:

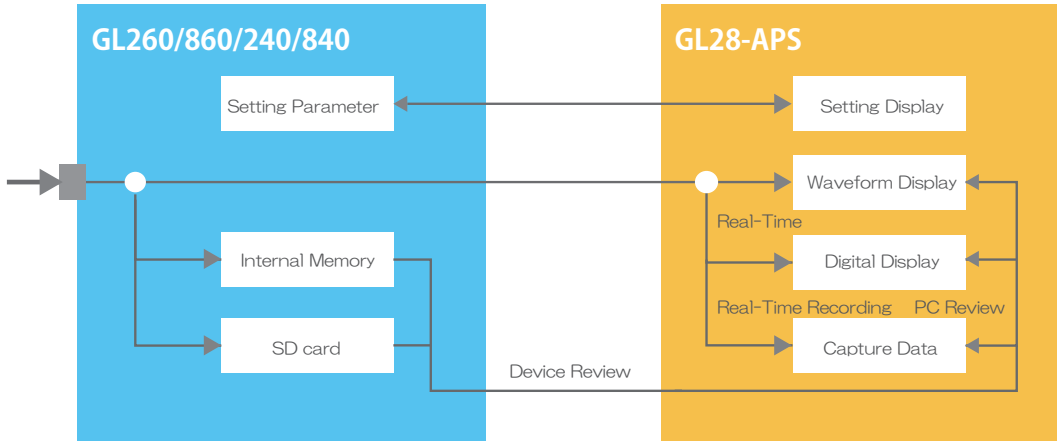

Operation	Description
Controls of Main Unit	Configuration parameters of the GL will be configured or referenced from the configuration screen of this software.
Real-Time Display of the Waveform Screen and Digital Screen	Data from the GL will be received in real-time and displayed on the waveform screen or the digital screen.
Real-Time Recording	Data from the GL will be received in real-time and saved on the PC. Recording will also be performed with the GL on the built-in memory and SD card.
PC Playback and Unit Playback	Data saved on the PC will be displayed on the waveform screen or digital screen. In addition, the data recorded on the GL will be forwarded and displayed on the waveform screen or digital screen..

- If a communication error occurs during real-time recording to PC, data may be lost. In that case, please acquire the data saved on the GL main body side. In addition, please improve the communication environment.

7-2. Controlling Device

This software can perform the following operations:

- Start/Stop Data Capture
- AMP Settings (Input, Range, etc.)
- Data Capture Settings (Sampling Interval, etc.)
- Trigger, Alarm Settings (Trigger Settings, Alarm Settings, etc.)
- Other Settings (Temperature Unit, Factory Default Settings, etc.)

7-3. Language Setting

Switch the displayed language. It will be necessary to reactivate this software in order for the configuration to be reflected.

Since garbled occurs, please use the OS of the corresponding language.

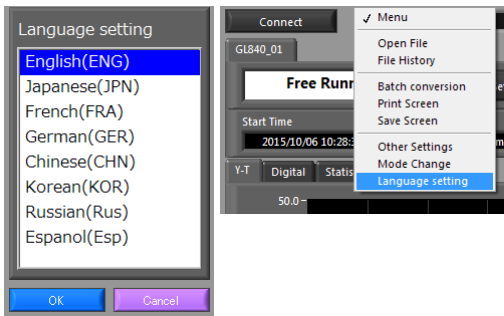

7-4. PC Connection Settings

Configure the communication settings between GL and a PC.

1. Click the "Connect" in the Main screen, and the Connection screen will be displayed.

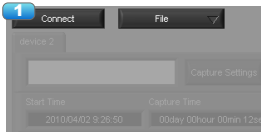

2. Select "Choose".
3. Select "Search".

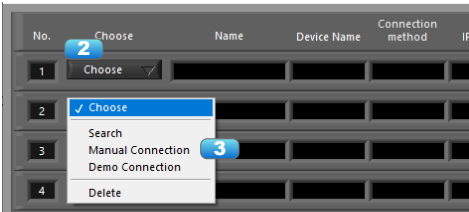

4. Device List window opens, and searches for connectable devices.
5. If no device is found, press the "Updated" button. Searchable devices are USB connected devices, LAN connected devices (only in same segment).
6. Select the device to connect and press "Choose".



7. If necessary, the name can be changed as desired. ("\" / : * ? " < > |" cannot be used)
8. Setting groups. By setting multiple devices as a same group number, capture can be start and stop at the same timing for that group.
9. Press the "Connect" button to make communication connection. "OK" is displayed in the status when connection is completed. "NG" is displayed when not connected. "REC" is displayed during recording.

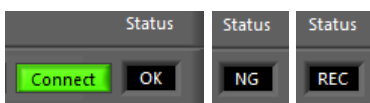

10. Click the "Close" button to close the Connect screen.

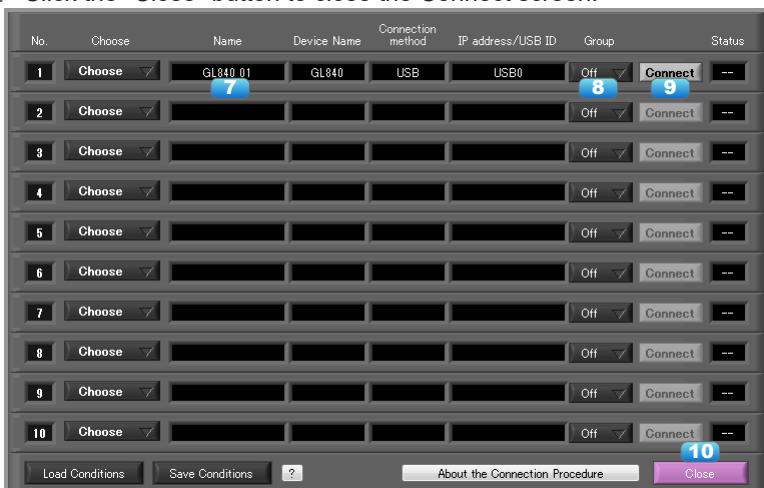

● CHECKPOINT

- Before making a connection, check that this unit is either in a "STOP" or "REC" status.
 - When they are connected, the software works with the setting conditions read from the GL unit. When you want to use the PC's settings, press the "Read Setting Conditions" button to read the saved configuration file. To do this, you should save the setting conditions.
- The following settings are not saved to this unit.
- Setting items not available on the GL unit
 - Line color settings
 - Annotation Settings
 - Trigger time, duration, and repeated capture settings
- After a connection is established, the time on the PC is transferred to this unit. Note that the time of this unit will be changed.
-

Demo Connection

Demo Connection will not connect to the GL unit, but will be connected by a simulated connect. A prepared demo waveform will be displayed.

Select "Demo Connection" from "Choose".

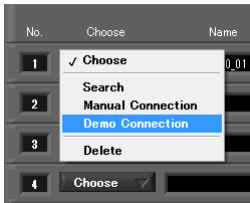

Select the device name to be connected by Demo Connection.



Manual Connection

Select "Manual Connection" from "Choose".

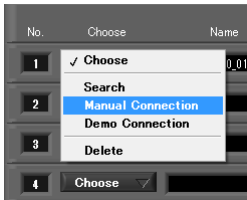

Set the IP address and port number of the device to be connected.

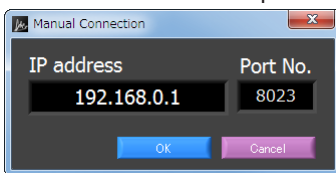

Press the OK button to confirm.

Load Condition and Save Condition

Save the settings in the "Save Condition", to read in the "Load condition". The file format * .cfg.



7-11. Display Screens

This section explains the display screens in Free Running or Capturing status in this software.

- Y-T

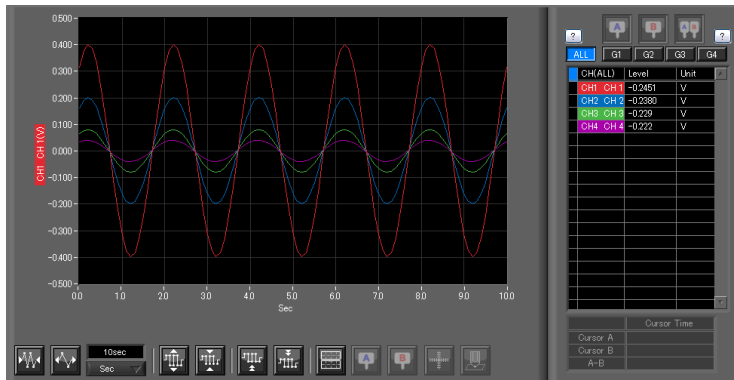

- Digital



- Statistics and History Display

The Statistics and History Display screen shows a table of channel data. The table includes columns for Channel (CH), Annotation, Min, Min Time, Max, Max Time, Average, and Unit. The Alarm Log section on the right shows the occurrence time for each channel.

CH	Annotation	Min	Min Time	Max	Max Time	Average	Unit
CH1	CH 1	-0.2201	15-05-21 17:45:34	+0.2088	15-05-21 17:45:37	-0.0063	V
CH2	CH 2	-0.2185	15-05-21 17:45:34	+0.2101	15-05-21 17:45:37	-0.0047	V
CH3	CH 3	-0.002	15-05-21 17:45:34	-0.001	15-05-21 17:45:37	-0.001	V
CH4	CH 4	+0.0010	15-05-21 17:45:34	+0.0010	15-05-21 17:45:36	+0.0013	V
CH5	CH 5	-0.0002	15-05-21 17:45:34	-0.0002	15-05-21 17:45:34	-0.0002	V
CH6	CH 6	-0.0010	15-05-21 17:45:34	-0.0003	15-05-21 17:45:36	-0.0006	V
CH7	CH 7	+0.0009	15-05-21 17:45:36	+0.0011	15-05-21 17:45:34	+0.0010	V
CH8	CH 8	-0.0013	15-05-21 17:45:37	-0.0010	15-05-21 17:45:34	-0.0011	V
CH9	CH 9	+0.0010	15-05-21 17:45:34	+0.0016	15-05-21 17:45:36	+0.0013	V
CH10	CH10	-0.0002	15-05-21 17:45:35	-0.0001	15-05-21 17:45:34	-0.0001	V
GS1	GS1	+0.00	15-05-21 17:45:34	+0.00	15-05-21 17:45:34	+0.00	A
GS2	GS2	+0.00	15-05-21 17:45:34	+0.00	15-05-21 17:45:34	+0.00	kW
GS3	GS3	+0.00	15-05-21 17:45:34	+0.00	15-05-21 17:45:34	+0.00	A
GS4	GS4	+0.00	15-05-21 17:45:34	+0.00	15-05-21 17:45:34	+0.00	kW
WL1-1	WL1-1	+0.00	15-05-21 17:45:34	+0.00	15-05-21 17:45:34	+0.00	A
WL1-2	WL1-2	+0.00	15-05-21 17:45:34	+0.00	15-05-21 17:45:34	+0.00	kW
WL1-3	WL1-3	+0.00	15-05-21 17:45:34	+0.00	15-05-21 17:45:34	+0.00	A
WL1-4	WL1-4	+0.00	15-05-21 17:45:34	+0.00	15-05-21 17:45:34	+0.00	kW
WL1-5	WL1-5	+0.00	15-05-21 17:45:34	+0.00	15-05-21 17:45:34	+0.00	degC
WL1-6	WL1-6	+0.00	15-05-21 17:45:34	+0.00	15-05-21 17:45:34	+0.00	A
WL1-7	WL1-7	+0.00	15-05-21 17:45:34	+0.00	15-05-21 17:45:34	+0.00	degC
WL1-8	WL1-8	+0	15-05-21 17:45:34	+0	15-05-21 17:45:34	+0	degCh
WL2-1	WL2-1	+0.00	15-05-21 17:45:34	+0.00	15-05-21 17:45:34	+0.00	A

- Accumulated Graph Display (only for GL240 and GL840)

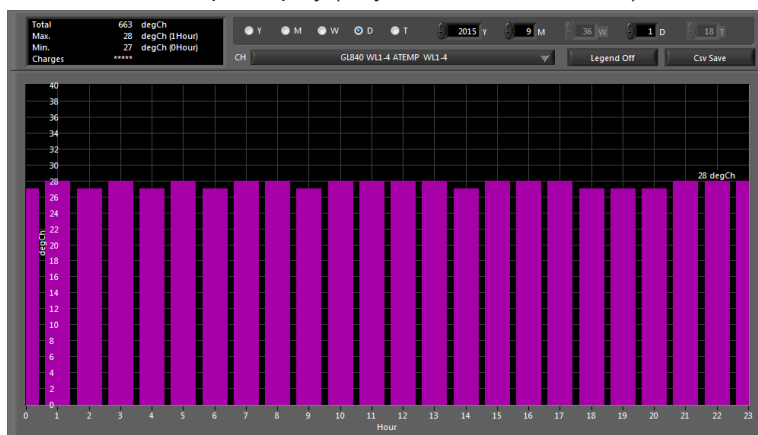

7-11-1. Y-T (Main Screen)

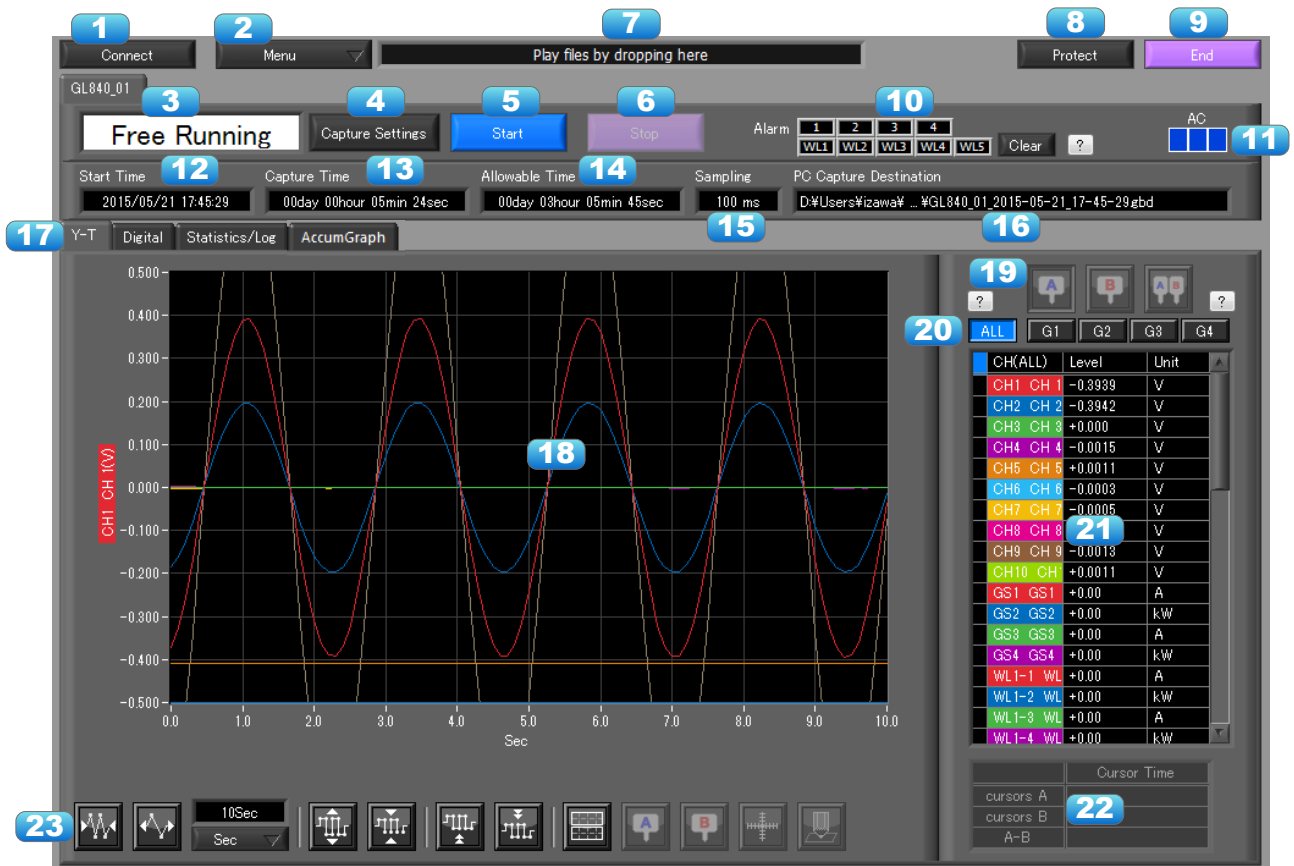

No.	Name	Description														
1	Connect	Opens a screen for connecting to this unit.														
2	Menu	<p>Conducts file-related operations.</p> <table border="1"> <tr> <td>Open File</td> <td>Displays the data in files stored on the PC or files stored on this unit as waveforms.</td> </tr> <tr> <td>File History</td> <td>Files opened, captured, and converted in the past will be listed as log and can be played.</td> </tr> <tr> <td>CSV file batch conversion</td> <td>Click this button to convert multiple GBD (binary data) files captured to the PC to CSV files.</td> </tr> <tr> <td>Print Screen</td> <td>Click this button to print out a copy of the screen. Printing is performed at the printer that has been selected as the default printer. If you change the printer, relaunch the software.</td> </tr> <tr> <td>Save Screen</td> <td>Click this button to save the displayed screen as a BMP file.</td> </tr> <tr> <td>Other Settings</td> <td>Configures power charge settings and CSV settings.</td> </tr> <tr> <td>Language Settings</td> <td>Switch the displayed language. It will be necessary to reactivate this software in order for the configuration to be reflected.</td> </tr> </table>	Open File	Displays the data in files stored on the PC or files stored on this unit as waveforms.	File History	Files opened, captured, and converted in the past will be listed as log and can be played.	CSV file batch conversion	Click this button to convert multiple GBD (binary data) files captured to the PC to CSV files.	Print Screen	Click this button to print out a copy of the screen. Printing is performed at the printer that has been selected as the default printer. If you change the printer, relaunch the software.	Save Screen	Click this button to save the displayed screen as a BMP file.	Other Settings	Configures power charge settings and CSV settings.	Language Settings	Switch the displayed language. It will be necessary to reactivate this software in order for the configuration to be reflected.
Open File	Displays the data in files stored on the PC or files stored on this unit as waveforms.															
File History	Files opened, captured, and converted in the past will be listed as log and can be played.															
CSV file batch conversion	Click this button to convert multiple GBD (binary data) files captured to the PC to CSV files.															
Print Screen	Click this button to print out a copy of the screen. Printing is performed at the printer that has been selected as the default printer. If you change the printer, relaunch the software.															
Save Screen	Click this button to save the displayed screen as a BMP file.															
Other Settings	Configures power charge settings and CSV settings.															
Language Settings	Switch the displayed language. It will be necessary to reactivate this software in order for the configuration to be reflected.															
3	Simplified message area	<p>The operating status is displayed here.</p> <table border="1"> <tr> <td>Free Running</td> <td>Stopped status (not capturing data)</td> </tr> <tr> <td>Armed</td> <td>Awaiting trigger activation; data has not been captured.</td> </tr> <tr> <td>Recording</td> <td>Data capture status</td> </tr> <tr> <td>Finished</td> <td>Recording end status. Press the "Stop" button.</td> </tr> </table>	Free Running	Stopped status (not capturing data)	Armed	Awaiting trigger activation; data has not been captured.	Recording	Data capture status	Finished	Recording end status. Press the "Stop" button.						
Free Running	Stopped status (not capturing data)															
Armed	Awaiting trigger activation; data has not been captured.															
Recording	Data capture status															
Finished	Recording end status. Press the "Stop" button.															
4	Capture Settings	Click this button to open the data capture settings screen. Refer to "Setting Screen" for details.														
5	Start	Click this button to start data capture.														

6	Stop	Click this button to stop data capture.						
7	File drop playing area	Files can be played by dropping GBD/CSV files in this area.						
8	Protect	Click this button to set the password to protect the software. * Protection operations occur only in this software. Be careful that this software can be exited via Windows operations.						
9	End	Click this button to exit the application.						
10	Alarm	Alarm output port state will be displayed. <table border="1" data-bbox="523 434 1406 555"> <tr> <td>1 - 4</td> <td>Device alarm</td> </tr> <tr> <td>WL1 - WL5</td> <td>Alarm on GL100 remote. (GL240, GL840 only)</td> </tr> <tr> <td>RT1 - RT5</td> <td>Alarm on GLT400 remote connected to GL840.</td> </tr> </table>	1 - 4	Device alarm	WL1 - WL5	Alarm on GL100 remote. (GL240, GL840 only)	RT1 - RT5	Alarm on GLT400 remote connected to GL840.
1 - 4	Device alarm							
WL1 - WL5	Alarm on GL100 remote. (GL240, GL840 only)							
RT1 - RT5	Alarm on GLT400 remote connected to GL840.							
11	AC/Battery	Power source state will be displayed. Battery residual charge during battery operation can be confirmed.						
12	Start Time	Data capture start time.						
13	Capture Time	The amount of time that has elapsed since the start of data capture.						
14	Allowable Time	The amount of time available for data capture. When the remaining time is up, data capture stops at both the device and the PC.						
15	Sampling Interval	The sampling interval. * EXT is displayed during external sampling.						
16	PC Capture Destination	The data capture destination at the PC.						
17	Screen switching	Switches between screens (Y-T/Digital/Statistics and History/Accume Graph Views). *Accumme graph display is available only for GL240 and GL840.						
18	Waveform Graph	The waveforms are displayed here.						
19	Cursors	Selects which of the cursor values should be displayed in the digital display area when scroll is stopped during capture. Up to three values (Cursor A, Cursor B, Cursor A-B) can be displayed at the same time. This function is available when the scroll is Off during capture, or during replay.						
20	Switch displayed groups	Click one of these buttons to select a group whose waveform and digital values are displayed.						
21	Digital	The digital values are displayed in this area. Clicking on any of the CH numbers enables the waveform for that channel to be hidden/displayed. The channels for which an alarm has been generated are shown in red. The waveform display On/Off setting is cleared when the capture settings are changed and is reset to On.						
22	Cursor Time	The cursor times are displayed during data capture when Scroll Off has been selected.						
23	Waveform Op.	Click this button to perform various settings for the waveform display.						

7-11-2. Digital

The captured data is displayed as digital values. Instantaneous values are displayed in large characters to enable easy confirmation.



No.	Name	Description						
1	Analog	Digital values are displayed here.						
2	Set displayed CH	Click one of these buttons to select 20 analog channels to display the digital values. <table border="1" data-bbox="523 1093 1406 1211"> <tr> <td>1 - 200</td> <td>Device analog channels</td> </tr> <tr> <td>WL1 - WL5</td> <td>Analog channel of GL100 remote. (GL240, GL840 only)</td> </tr> <tr> <td>RT1 - RT5</td> <td>Analog channel of GLT400 remote connected to GL840.</td> </tr> </table>	1 - 200	Device analog channels	WL1 - WL5	Analog channel of GL100 remote. (GL240, GL840 only)	RT1 - RT5	Analog channel of GLT400 remote connected to GL840.
1 - 200	Device analog channels							
WL1 - WL5	Analog channel of GL100 remote. (GL240, GL840 only)							
RT1 - RT5	Analog channel of GLT400 remote connected to GL840.							
3	Pulse	Pulse signals' digital values are displayed here. (when the Logic/Pulse setting is "Pulse")						
4	Logic	Logic signals' digital values are displayed here. (when the Logic/Pulse setting is "Logic")						

7-11-3. Statistics and History

During recording, statistics such as maximum, minimum and average value of each CH is displayed. Alarm operation history is displayed in list format.

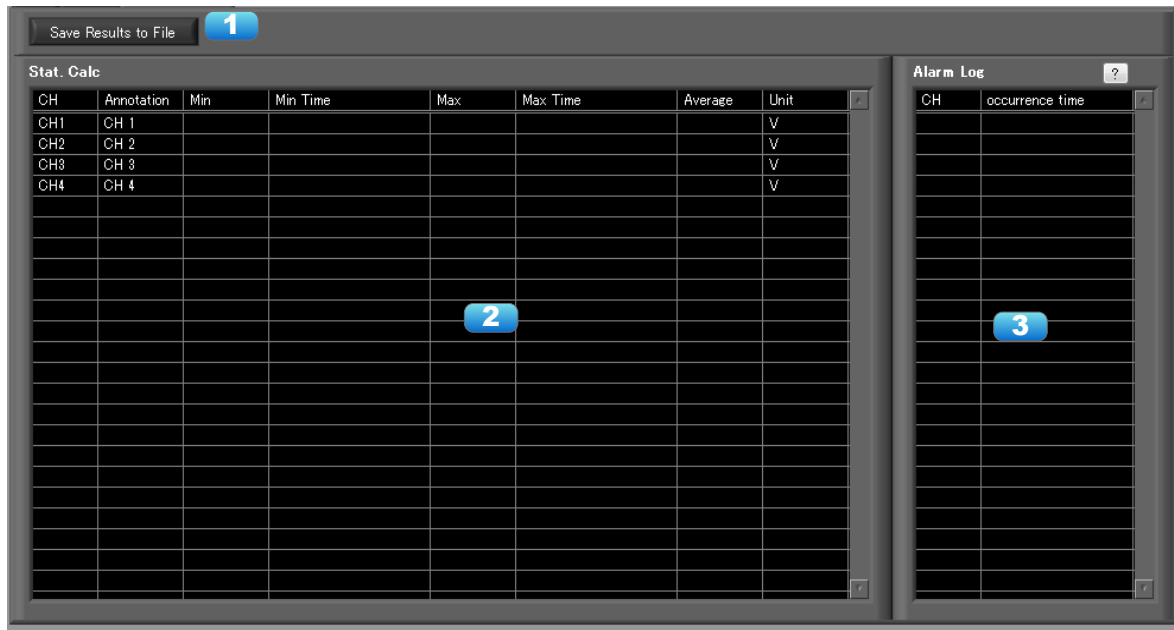

No.	Name	Description
1	Saving results to a file	The details displayed in the list are saved in CSV file format.
2	Statistical List Display	Displays statistical value of each CH.
3	Alarm History	Displays history of alarm operation. Maximum of 100 alarms are displayed.

7-11-4. Accumulated Graph Display

The accumulated data of a temperature and humidity sensor (GS-TH), luminance and UV ray sensor (GS-LXUV), and power sensor (DPA-AC) connected to GL240/ or 840 can be displayed as time-based bar graphs in the accumulated graphs. The results for a chosen month or day can be confirmed by switching the period. It is also possible to output the displayed data in the form of a CSV file.

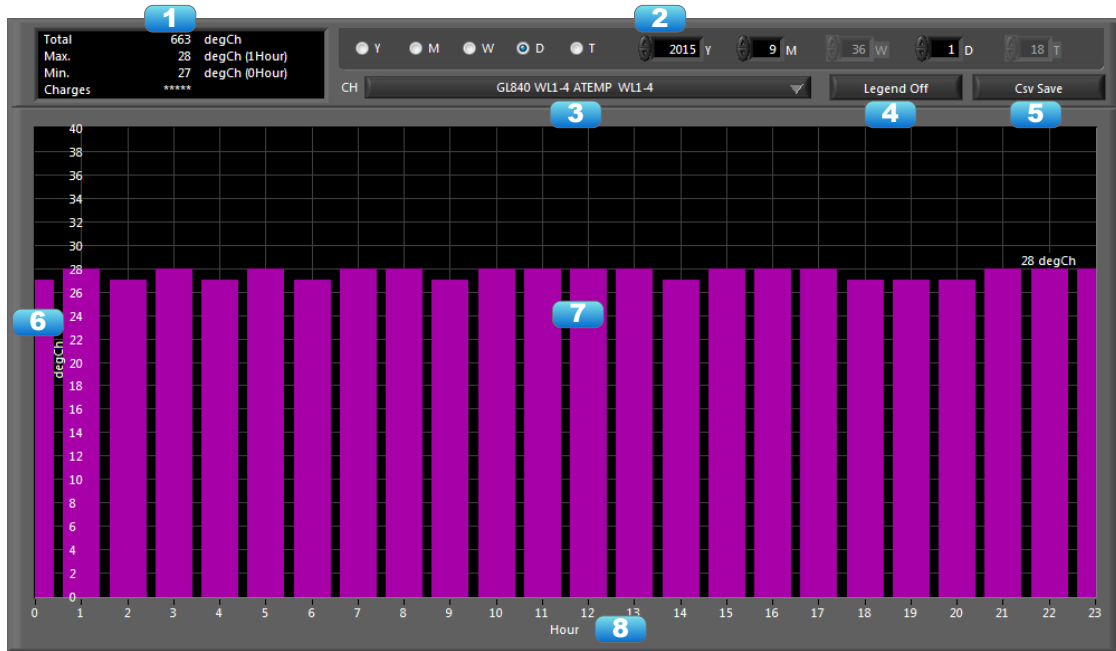

No.	Name	Description	
1	Information Display	Displays information of the accumulated graph that is being displayed.	
		Total	Displays the total volume of the accumulated graph that is being displayed.
		Max	Displays the maximum value and the time of occurrence of the accumulated graph that is being displayed.
		Min	Displays the minimum value and the time of occurrence of the accumulated graph that is being displayed.
2	Period Settings	Charges	Displays the power charges and unit price for charges when the accumulated data is accumulated power. (The unit price will not be displayed when displaying the accumulated integration.)
		Configures the period displayed in the accumulated graph.	
		Y (Year)	Sets the period to the unit of a single year. The entire screen will display 12 months where each bar in the graph will represent one month.
		M (Month)	Sets the period to the unit of a single month. The entire screen will display 31 days where each bar in the graph will represent one day. (Regardless of the different number of days in each month, the display will be fixed for 31 days.)
		W (Week)	Sets the period to the unit of a single week. The weeks will be numbered starting with the beginning of the year. The entire screen will display 7 days where each bar in the graph will represent one day. The first bar will represent Sunday. * The week number is what January 1 is included in the first week of the year (USA system).
		D (Day)	Sets the period to the unit of a single day. The entire screen will display 24 hours where each bar in the graph will represent one hour.
	H (Hour)	Sets the period to the unit of a single hour. The entire screen will display 60 minutes where each bar in the graph will represent one minute.	

3	CH Select	Selects the channel to display in the accumulated graph. A selection cannot be made when there are no possible options. For all of the applicable data, when there are multiple channels for each the accumulated temperature, accumulated luminance, accumulated UV rays, and accumulated power, channels will be added to display accumulated integrations of the same type of data. The conditions for displaying the accumulated integrations are as follows: - When there are multiple channels for the accumulated temperature (note that Celsius and Fahrenheit are counted separately) - When there are multiple channels for the accumulated luminance (if different ranges are included, the largest range will serve as a standard) - When there are multiple channels for the accumulated UV rays - When there are multiple channels for the accumulated power
4	Legend	Displays the legend for the channel selected with CH Select. Device name (none during playback), CH number, input name, annotation. The legend for multiple channels will be displayed when displaying an accumulated integration. The wave colors will be reassigned upon accumulated integration.
5	CSV Save	Outputs the graph that is being displayed in the form of a CSV file. The following is an example of this output.
6	Y-Axis Scale	Displays the Y-axis scale of the bar graph. The scale will be determined and automatically adjusted based on the graph being displayed. It is also possible to directly input a value for the scale. However, note that the scale will be automatically adjusted again when the period, etc. is switched.
7	Bar Graph	Displays the bar graph. The values for individual graphs can be confirmed by moving the cursor over each bar graph. Further, double-clicking on a bar graph switches the display to the period of the applicable bar graph.
8	X-Axis Scale	Displays the X-axis scale of the bar graph. It is also possible to directly input a value for the scale. However, note that the scale will be automatically adjusted again when the period, etc. is switched.

● If set to external sampling, this function does not function properly.

Accumulated Integration Graph



Legend Display

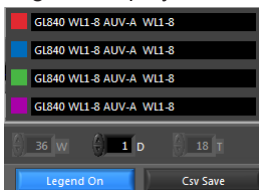

Example of CSV Output

	A	B	C	D	E	F	G	H
1	Vendor	Graphtec Corporation						
2	Model	GL28-APS						
3	Version	1						
4	Created	2023/5/16	11:18					
5	Period	2023/5/1	0:00:00 ~		2023/5/1	23:59:59		
6								
7	CH	Pile up AILLUM						
8	Total	36 kbxh						
9	Max	18 kbxh		10Hour				
10	Min	0 kbxh		Hour				
11	Charges							
12								
13	Hour	GL840 GS7 AILLUM GS7(kbxh)	GL840 WLS-3 AILLUM WLS-3(kbxh)	GL840 GS7 AILLUM GS7(kbxh)	GL840 WLS-3 AILLUM WLS-3(kbxh)	GL840 GS7 AILLUM GS7(kbxh)	GL840 WLS-3 AILLUM WLS-3(kbxh)	Pile up AILLUM(kbxh)
14	0	0	0	0	0	0	0	0
15	1	0	0	0	0	0	0	0
16	2	0	0	0	0	0	0	0
17	3	0	0	0	0	0	0	0
18	4	0	0	0	0	0	0	0
19	5	0	0	0	0	0	0	0
20	6	0	0	0	0	0	0	0
21	7	0	0	0	0	0	0	0
22	8	0	0	0	0	0	0	0
23	9	0	0	0	0	0	0	0
24	10	5	1	5	1	5	1	18
25	11	4	0	4	0	4	0	12
26	12	2	0	2	0	2	0	6
27	13	0	0	0	0	0	0	0
28	14	0	0	0	0	0	0	0
29	15	0	0	0	0	0	0	0
30	16	0	0	0	0	0	0	0
31	17	0	0	0	0	0	0	0
32	18	0	0	0	0	0	0	0
33	19	0	0	0	0	0	0	0
34	20	0	0	0	0	0	0	0
35	21	0	0	0	0	0	0	0
36	22	0	0	0	0	0	0	0
37	23	0	0	0	0	0	0	0
38	24	0	0	0	0	0	0	0

7-12. Settings Screens

This chapter describes the screens used to perform settings related to data capture.

7-12-1. AMP Settings

This screen is used to make the analog input, logic input, and pulse input settings.

7-12-1-1. Amp Settings

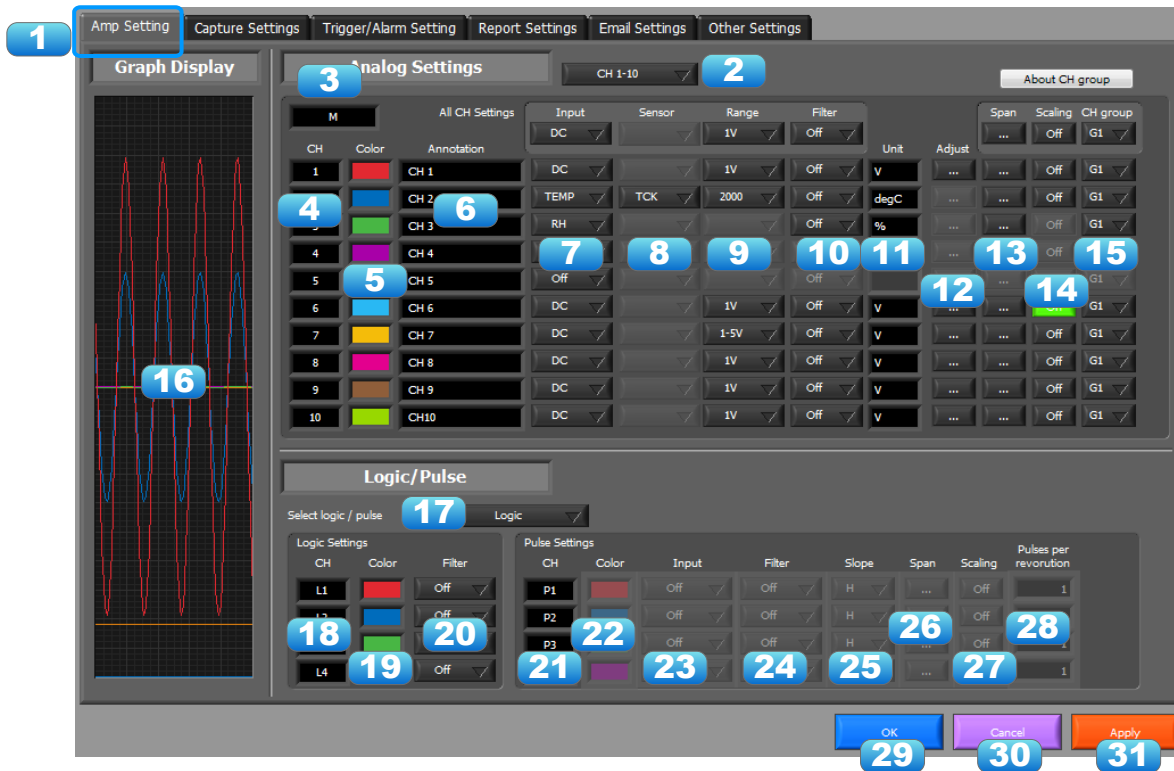

No.	Name	Description	
1	Settings tabs	These tabs are used to change the settings screen.	
		AMP Settings	This tab is used to make input-related settings.
		Data Capture Settings	This tab used to make settings related to data capture.
		Trigger/Alarm Settings	This tab is used to make settings related to the trigger and alarm functions.
		Report Settings	This tab is used to make settings related to the daily report, monthly report, and Export to Direct Excel File functions
		Email Settings	Settings for sending emails.
2	CH Switching	Other Settings	This tab is used to make various other settings, to display information, and so forth.
		Switch channels to be set.	

No.	Name	Description			
3	Amp Name	Display the amp name.			
		M2	Standard 20ch terminal (GL860, GL840 Ver1.7 or later)	VT	4ch voltage / temperature terminal
		SL2	Standard 20ch Screwless terminal (GL860, GL840 Ver1.7 or later)	AT	3-axis acceleration / temperature terminal
		SL3	Standard 30ch Screwless terminal (GL860)	TH	Temperature and humidity sensor
		M	Standard Terminal for GL840/GLT400	TSR	4ch thermistor terminal
		WV	High-voltage high-precision terminal	AC	Adapter for AC current sensor
		SL	Screwless terminal for GL840/GLT400	CO2	CO2 sensor
		OM	Old terminal (GL820/800)	LU	Illumination / ultraviolet sensor
4	CH	These are the channel numbers for analog input.			
5	Color	The color used for the waveform for each channel can be specified here. * Color settings are the setting values for the software and a different color may be shown during recording and playing.			
6	Annotation	Each channel can be freely annotated (input the signal name, etc.). The maximum number of characters is 31 (in single-byte). *Annotation settings cannot be stored in recorded data. Since such settings are a setting value on the software, they may differ during recording and playing operations.			
7	Input	Setting contents will differ by each model and sensor. Refer to the instruction manual for details of each models.			
8	Sensor	Setting contents will differ by each model and sensor. Refer to the instruction manual for details of each models.			
9	Range	Setting contents will differ by each model and sensor. Refer to the instruction manual for details of each models.			
10	Filter	Use these buttons to set the filter for each channel. Moving average processing is used in the filter. It captures the data for configured number of times at the configured sampling rate and performs average processing. (Off/2/5/10/20/40)			
11	Unit	The selected unit is displayed here.			
12	Adjust	Setting items are required when a sensor has an adjust function.			
13	Span	Use these buttons to set the upper limit and lower limit values for the waveforms displayed in the waveform graph.			
14	Scaling	Use these buttons to convert the unit.			
15	CH Group	Use these buttons to set the display group for each channel. Only the groups set here can be viewed in Y-T display screen.			
16	Graph Display	The waveforms for which settings have been made can be checked here. Click the "Apply" button to apply the settings that have been made.			
17	Logic/Pulse switching	Use this button to switch the digital input. Logic, Pulse, or OFF can be set here. (Off/Pulse/Logic)			
18	Logic CH number	The channel numbers for logic input.			
19	Logic Line Color	Make the logic waveform color setting here.			
20	Logic Filter	Make the logic filter setting here. The filter is about -3dB at about 30Hz. (Off/On)			
21	Pulse CH number	The channel numbers for pulse input.			
22	Pulse Line Color	Make the pulse line color setting here.			

No.	Name	Description						
23	Pulse Input	Use the Input button to select the pulse input type. * The upper limit of the count in one sample is 50k.						
		<table border="1"> <tr> <td>Revolutions</td> <td>The number of pulses generated in one second is counted, multiplied by sampling interval, and displayed as the number of revolutions (RPM).</td> </tr> <tr> <td>Counts</td> <td>A cumulative count is made of the number of pulses generated in one sample.</td> </tr> <tr> <td>Inst.</td> <td>The number of pulses generated in one sample is counted.</td> </tr> </table>	Revolutions	The number of pulses generated in one second is counted, multiplied by sampling interval, and displayed as the number of revolutions (RPM).	Counts	A cumulative count is made of the number of pulses generated in one sample.	Inst.	The number of pulses generated in one sample is counted.
		Revolutions	The number of pulses generated in one second is counted, multiplied by sampling interval, and displayed as the number of revolutions (RPM).					
		Counts	A cumulative count is made of the number of pulses generated in one sample.					
Inst.	The number of pulses generated in one sample is counted.							
24	Pulse Filter	Make the pulse filter setting here. The filter is about -3dB at about 30Hz. (Off/On)						
25	Pulse Slope	Use this button to select the pulse detection slope.						
		<table border="1"> <tr> <td>H</td> <td>Rising signals are counted.</td> </tr> <tr> <td>L</td> <td>Falling signals are counted.</td> </tr> </table>	H	Rising signals are counted.	L	Falling signals are counted.		
		H	Rising signals are counted.					
L	Falling signals are counted.							
26	Pulse Span	Use this button to set the upper limit and lower limit values for the waveforms displayed in the waveform graph.						
27	Pulse Scaling	Use this button to convert the unit.						
28	Pulses per revolution	Set the pulses per revolution. Only valid when the input is "Revolutions".						
29	OK	Click this button to register your settings and close the screen.						
30	Cancel	Click this button to close the screen without registering your settings.						
31	Apply	Click this button to apply the settings mode.						

7-12-1-2. Auto zero settings

Performs zero adjustment.

The adjustable range is $\pm 10\%$ of the setting range.

(Example: For a range of 1V, the full scale is ± 1 V, and the adjustable range is ± 100 mV.)

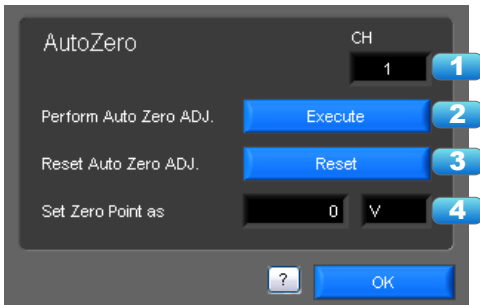

No.	Name	Description
1	CH	Displays a channel for which Auto Zero ADJ. should be performed.
2	Perform Auto Zero ADJ.	Performs Auto Zero ADJ. * If you have changed the input or range just before this step, first click "Apply" in the capture setting screen.
3	Reset Auto Zero ADJ.	Resets the zero adjustment to the initial state. * Changing the range will reset this setting.
4	Zero position voltage value	Displays the adjusted value after Zero ADJ.

7-12-1-3. Span Settings

Span settings are made at this screen.

To make the settings, input numerical values directly or use a cursor to adjust values.

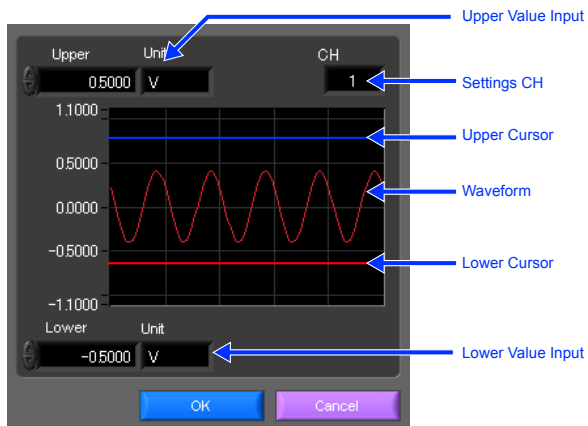

7-12-1-4. Scaling Settings

Sets the scaling (unit conversion). Enter the upper and lower limits of the input and converted values. For the temperature channel, the offset setting with two points is used.

* If you have changed the input from the temperature or voltage just before retrieving the temperature measurement values, first click "Apply" in the capture setting screen.

*Polarity reversal setting does not correspond.

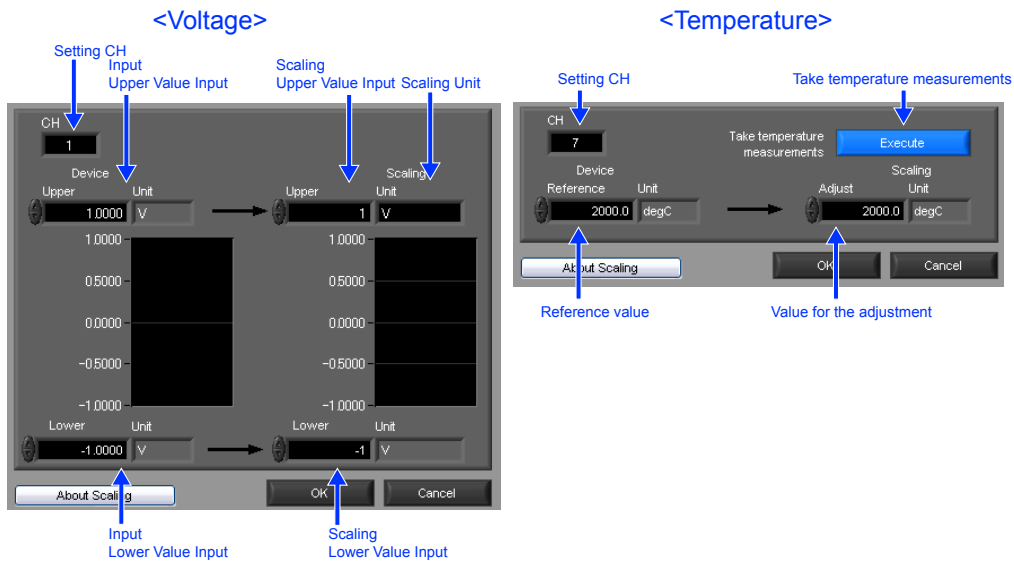

7-12-2. Data Capture Settings

Settings such as the Sampling Interval, Device Capture Settings and PC Capture Settings are made at this screen.

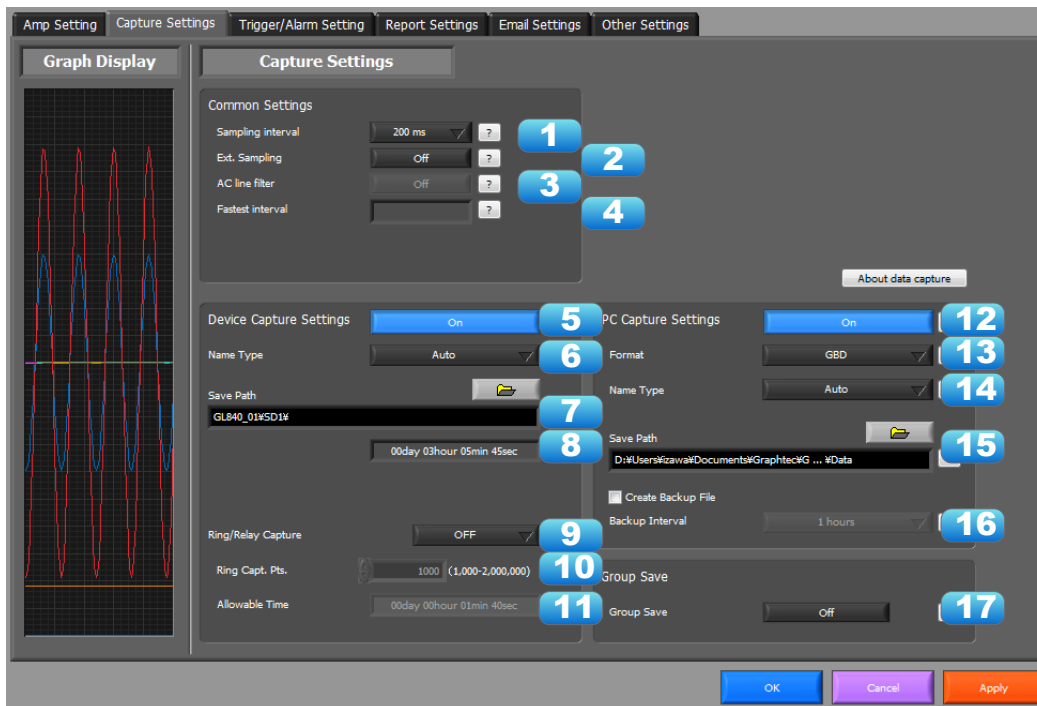

No.	Name	Description				
1	Sampling Interval	Specifies the sampling interval for data capture. The sampling interval that can be specified depends on the number of measured channels. Refer to the User's Manual for details.				
2	External sampling	Sets the external sampling function to On or Off. If set to On, data is captured using signals entered from the external input terminal. Signals that can be entered from the external input terminal must be slower than the "fastest interval" display. Refer to the User's Manual for details.				
3	AC Line Filter	Sets the AC line filter function to On or Off in the external sampling settings. The On or Off setting will change the fastest interval of the external sampling. Refer to the User's Manual for details.				
4	Fastest interval	Displays the fastest interval of external sampling when the external sampling function is used. The fastest interval varies with the AC line filter setting and the number of measurement channels. Refer to the User's Manual for details.				
5	Device Capture Destination Settings button	Use this button to specify the On/Off of data capture of the GL device. <table border="1"> <tr> <td>On</td> <td>Data capture operation is also performed on the GL device. Data capture cannot be started when there is no space in the data capture destination of the device. Data is captured to both the device and the PC.</td> </tr> <tr> <td>Off</td> <td>Data capture operation is not performed on the GL device. Data capture can be started when there is no space in the data capture destination of the device. Data is captured only to the PC.</td> </tr> </table>	On	Data capture operation is also performed on the GL device. Data capture cannot be started when there is no space in the data capture destination of the device. Data is captured to both the device and the PC.	Off	Data capture operation is not performed on the GL device. Data capture can be started when there is no space in the data capture destination of the device. Data is captured only to the PC.
On	Data capture operation is also performed on the GL device. Data capture cannot be started when there is no space in the data capture destination of the device. Data is captured to both the device and the PC.					
Off	Data capture operation is not performed on the GL device. Data capture can be started when there is no space in the data capture destination of the device. Data is captured only to the PC.					
6	Device Capture Settings Name Type	Use this button to select the method for appending the file name. <table border="1"> <tr> <td>Auto</td> <td>Create a date folder in the specified folder, and then create a date and time file in it.. (Example: 2010-04-01_12-34-56.GBD)</td> </tr> <tr> <td>User</td> <td>The file name can be freely specified by the user.</td> </tr> </table>	Auto	Create a date folder in the specified folder, and then create a date and time file in it.. (Example: 2010-04-01_12-34-56.GBD)	User	The file name can be freely specified by the user.
Auto	Create a date folder in the specified folder, and then create a date and time file in it.. (Example: 2010-04-01_12-34-56.GBD)					
User	The file name can be freely specified by the user.					
7	Device Capture Settings Save Path	The save destination at the device for the captured data is selected here.				

No.	Name	Description				
8	Device Capture Settings Allowable capture time	The length of time available for data capture to the selected device storage medium is displayed here.				
9	Ring/Relay Capture	Ring Capture: This function deletes old data during capture when the set Ring Capt. Pts. is exceeded. Relay recording: Files are separated in 2GB units for continuous recording. (*GL240, GL840 Ver1.43 or earlier only) Relay recording: Separate files and record continuously according to the set relay time/volume (GL860, GL260, GL840 Ver1.44 or later only). Memory Loop: Can be set only when the ring relay setting is relay. If the remaining capacity runs out during relay recording, the oldest relay file being recorded is deleted and recording continues. (GL860, GL260 only) For details, please refer to the instruction manual of the main unit.				
10	Ring Capt. Pts.	Sets the number of capture points when Ring Capture is performed. Refer to the User's Manual for details.				
11	Ring Allowable Capture Time	Displays the time available for capture in Ring Capture. Refer to the User's Manual for details.				
12	Capture settings at PC side	Set the data capture ON/OFF at PC side.				
13	PC Capture Destination Settings button	Use this button to select the format of the data saved to the PC (personal computer). <table border="1" data-bbox="528 902 1406 1043"> <tr> <td>Binary format (GBD)</td> <td>The data is saved as binary data. When compared with a CSV file, the file size is somewhat small.</td> </tr> <tr> <td>Text format (CSV)</td> <td>The data is saved as text data in a format that can be displayed in Excel.</td> </tr> </table>	Binary format (GBD)	The data is saved as binary data. When compared with a CSV file, the file size is somewhat small.	Text format (CSV)	The data is saved as text data in a format that can be displayed in Excel.
Binary format (GBD)	The data is saved as binary data. When compared with a CSV file, the file size is somewhat small.					
Text format (CSV)	The data is saved as text data in a format that can be displayed in Excel.					
14	PC Capture Settings Name Type	Use this button to select the method for appending the file name. <table border="1" data-bbox="528 1093 1406 1263"> <tr> <td>Auto</td> <td>A folder with the date as the file name is created within the specified folder, and then a file with the date and time as the file name is created within the newly-created folder. (Example: Device1_2010-04-01_12-34-56.GBD)</td> </tr> <tr> <td>User</td> <td>The file name can be freely specified by the user.</td> </tr> </table>	Auto	A folder with the date as the file name is created within the specified folder, and then a file with the date and time as the file name is created within the newly-created folder. (Example: Device1_2010-04-01_12-34-56.GBD)	User	The file name can be freely specified by the user.
Auto	A folder with the date as the file name is created within the specified folder, and then a file with the date and time as the file name is created within the newly-created folder. (Example: Device1_2010-04-01_12-34-56.GBD)					
User	The file name can be freely specified by the user.					
15	PC Capture Settings Save Path	The save destination at the PC (personal computer) for the captured data is selected here.				
16	PC Capture Settings Create Backup File	To enable this function, click the checkbox to display the check mark. The backup file is created at the same location as that specified in Item 14 "Save Path" above. The "_bk" file extension is appended to the file name.				
17	PC Capture Settings Backup Interval	Use this button to select the backup interval. During data capture, a backup data file is created at the specified intervals. If all the backup files are linked, the data will be same as that of the original data. (1/2/6/12/24(h)) * A fluctuation of about 10 seconds will be generated in the backup interval. Therefore, the data size of a backup file fluctuates to some degree. Since there is no loss of data, however, you can concatenate backup files to obtain data equivalent to that of one backup file that you would obtain from continuous capture.				
18	Group Save	When multiple devices are set to the same group in the Connect screen, data will be integrated to the same file after capture when this function is set to ON. * Order of the channels of the save data will change.				

7-12-3. Trigger/Alarm Settings

Settings such as the trigger start condition, stop condition, alarm settings.

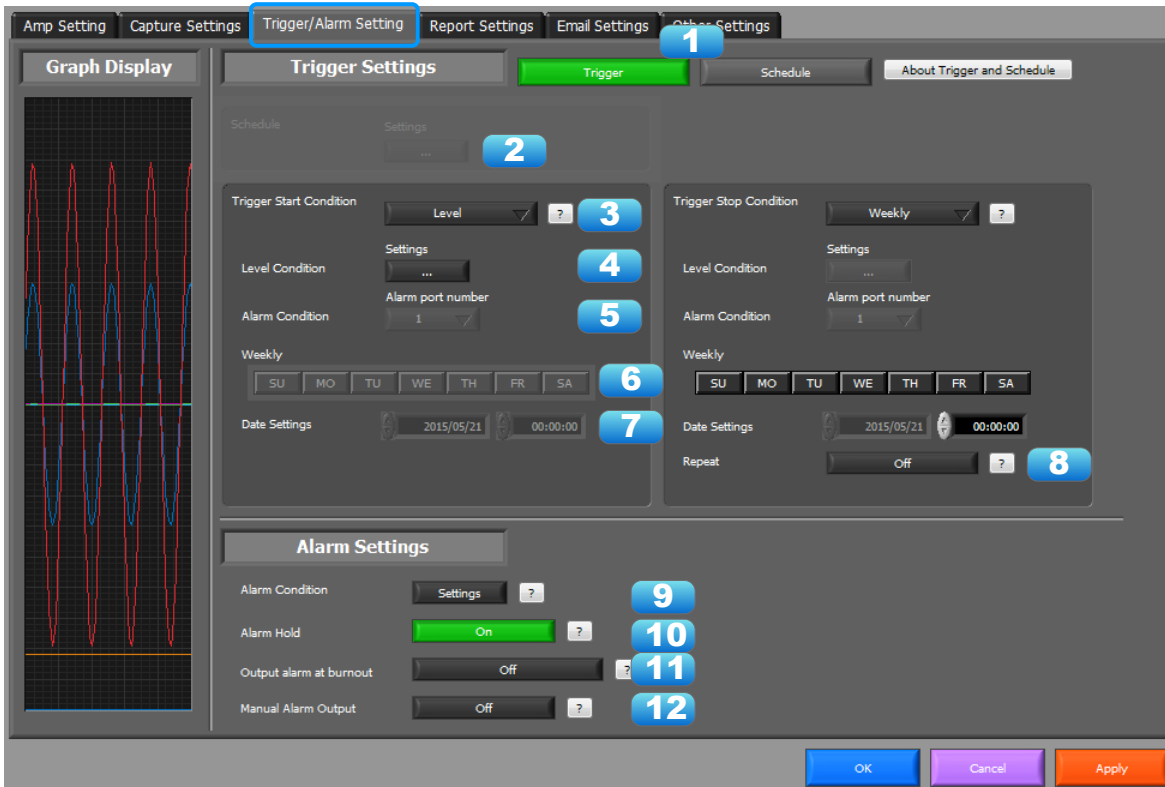

No.	Name	Description																
1	Trigger and Schedule	Either the trigger or schedule function of the GL unit can be selected for the capture condition. Both function cannot be used together.																
2	Schedule Settings	Set the schedule.																
3	Trigger Selection	Use this button to select the trigger start(stop) condition. <table border="1" style="width: 100%; border-collapse: collapse;"> <tr> <td style="width: 20%;">Off</td> <td>There is no data capture start condition. (There is no stop condition.)</td> </tr> <tr> <td>Level</td> <td>Data capture starts(stops) when the desired channel reaches the specified level value.</td> </tr> <tr> <td>Alarm</td> <td>Data capture starts(stops) when the specified alarm occurs.</td> </tr> <tr> <td>Date</td> <td>Data capture starts(stops) at the specified date and time. * Settings are available only if Repeated Capture is Off. * Settings are not transmitted to or received from this unit.</td> </tr> <tr> <td>Time</td> <td>Data capture starts(stops) at the specified time. * Settings are available only if Repeated Capture is On. * Settings are not transmitted to or received from this unit.</td> </tr> <tr> <td>External</td> <td>Data capture starts(stops) with the external terminal signal. Data capture starts when the external trigger signal detects a falling of about 2.5V or less.</td> </tr> <tr> <td>Week</td> <td>Starts (stops) capture when the specified day of the week arrives.</td> </tr> <tr> <td>Defined Time</td> <td>Starts (stops) capture when a specified length of time elapses.</td> </tr> </table>	Off	There is no data capture start condition. (There is no stop condition.)	Level	Data capture starts(stops) when the desired channel reaches the specified level value.	Alarm	Data capture starts(stops) when the specified alarm occurs.	Date	Data capture starts(stops) at the specified date and time. * Settings are available only if Repeated Capture is Off. * Settings are not transmitted to or received from this unit.	Time	Data capture starts(stops) at the specified time. * Settings are available only if Repeated Capture is On. * Settings are not transmitted to or received from this unit.	External	Data capture starts(stops) with the external terminal signal. Data capture starts when the external trigger signal detects a falling of about 2.5V or less.	Week	Starts (stops) capture when the specified day of the week arrives.	Defined Time	Starts (stops) capture when a specified length of time elapses.
Off	There is no data capture start condition. (There is no stop condition.)																	
Level	Data capture starts(stops) when the desired channel reaches the specified level value.																	
Alarm	Data capture starts(stops) when the specified alarm occurs.																	
Date	Data capture starts(stops) at the specified date and time. * Settings are available only if Repeated Capture is Off. * Settings are not transmitted to or received from this unit.																	
Time	Data capture starts(stops) at the specified time. * Settings are available only if Repeated Capture is On. * Settings are not transmitted to or received from this unit.																	
External	Data capture starts(stops) with the external terminal signal. Data capture starts when the external trigger signal detects a falling of about 2.5V or less.																	
Week	Starts (stops) capture when the specified day of the week arrives.																	
Defined Time	Starts (stops) capture when a specified length of time elapses.																	
4	Level Condition	If "Level" has been selected for the start(stop) condition, make the required level settings here.																
5	Alarm Condition	If "Alarm" has been selected for the trigger start(stop) condition, set the alarm number here. Select an alarm number 1/2/3/4/WL1/WL2/WL3/WL4/WL5.																
6	Week Settings	Sets the day of the week when the trigger start (stop) condition is "Week."																

No.	Name	Description				
7	Date Settings	Sets the Date for starting (stopping) the capture on a specified day of the week when the trigger start (stop) condition is "Date", "Time" and "Week".				
8	Repeat	If On has been selected, the device proceeds to perform the next data capture operation after a start(stop) trigger has been generated. * Does not transmit or receive the settings to or from this unit. This unit is always Off and the file name does not include "REP."				
9	Alarm Condition	Use this button to make the alarm level settings for each input.				
10	Alarm Hold	This parameter specifies whether to maintain or clear the alarm status. <table border="1" data-bbox="523 465 1406 725"> <tr> <td>On</td> <td>Once an alarm has been generated, the alarm status is maintained. The alarm generated on each channel is retained together with the alarm output status. To clear the alarm status, click the "Alarm Clear" button displayed in the "Alarm Screen".</td> </tr> <tr> <td>Off</td> <td>The alarm generated status is not maintained. If the alarm status is canceled, the alarm status and alarm output for each channel are canceled.</td> </tr> </table>	On	Once an alarm has been generated, the alarm status is maintained. The alarm generated on each channel is retained together with the alarm output status. To clear the alarm status, click the "Alarm Clear" button displayed in the "Alarm Screen".	Off	The alarm generated status is not maintained. If the alarm status is canceled, the alarm status and alarm output for each channel are canceled.
On	Once an alarm has been generated, the alarm status is maintained. The alarm generated on each channel is retained together with the alarm output status. To clear the alarm status, click the "Alarm Clear" button displayed in the "Alarm Screen".					
Off	The alarm generated status is not maintained. If the alarm status is canceled, the alarm status and alarm output for each channel are canceled.					
11	Output alarm at burnout	When set to On, an alarm is output when a burnout has occurred.				
12	Manual Alarm Output	Set the output condition of the alarm output port. <table border="1" data-bbox="523 842 1406 981"> <tr> <td>On</td> <td>Manually output the alarm port independently of the alarm. Output can be made by a mobile App.</td> </tr> <tr> <td>Off</td> <td>Output will be made to the alarm output port in conjunction with the alarm.</td> </tr> </table>	On	Manually output the alarm port independently of the alarm. Output can be made by a mobile App.	Off	Output will be made to the alarm output port in conjunction with the alarm.
On	Manually output the alarm port independently of the alarm. Output can be made by a mobile App.					
Off	Output will be made to the alarm output port in conjunction with the alarm.					

● CHECKPOINT

When the sampling is set to the External, the start trigger and the stop trigger cannot be set to the external at the same time. Also when the start trigger or the stop trigger is set to the External, if the sampling is set to the External, the start trigger or the stop trigger is force set to Off.

7-12-3-1. Schedule Settings

Multiple schedules can be set as desired. This cannot be used in conjunction with the device's trigger function.

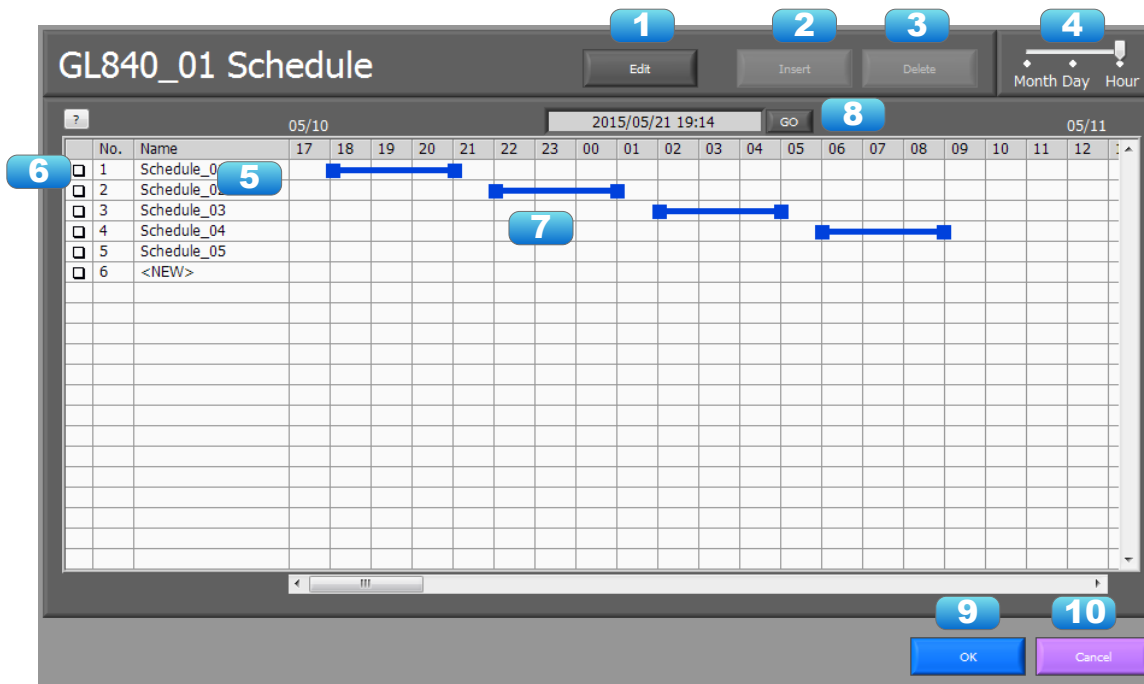

No.	Name	Description
1	Edit	Switch editable condition. If On (green), you can edit.
2	Insert	Insert the schedule.
3	Delete	Delete the selected schedule.
4	Time Axis Switching	Set the term to display.
5	Schedule Name	Display the set level. Refer to the following for details.
6	Detail Button	Open the detail setting screen.
7	Schedule	Input the schedule. Input can easily be made by dragging the mouse.
8	Move to the current time.	Move to the point of the current time.
9	OK	Confirm the setting and close.
10	Close	Close without confirming the setting.

Detail screen of the schedule

You can display the detail screen by double-clicking on the schedule name, or pressing the detail button.

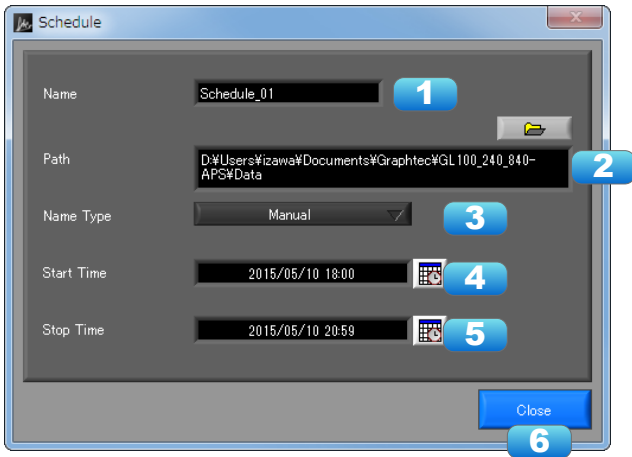

No.	Name	Description
1	Name	You can set the schedule name as desired. The schedule name will become the capture file name.
2	Path	You can set the destination for each schedule. Default is the same as the destination at the PC side of the capture settings.
3	Name Type	Auto Create a date folder in the specified folder, and then create a date and time file in it.
		User The file name can be freely specified by the user.
4	Start Time	You can set the detail start time by a numerical value.
5	Stop Time	You can set the detail stop time by a numerical value.
6	Close	Close screen.

7-12-3-2. Trigger Level Condition

If "Level" has been selected for the Trigger setting, the "Trigger Start/Stop Condition" settings must be made.

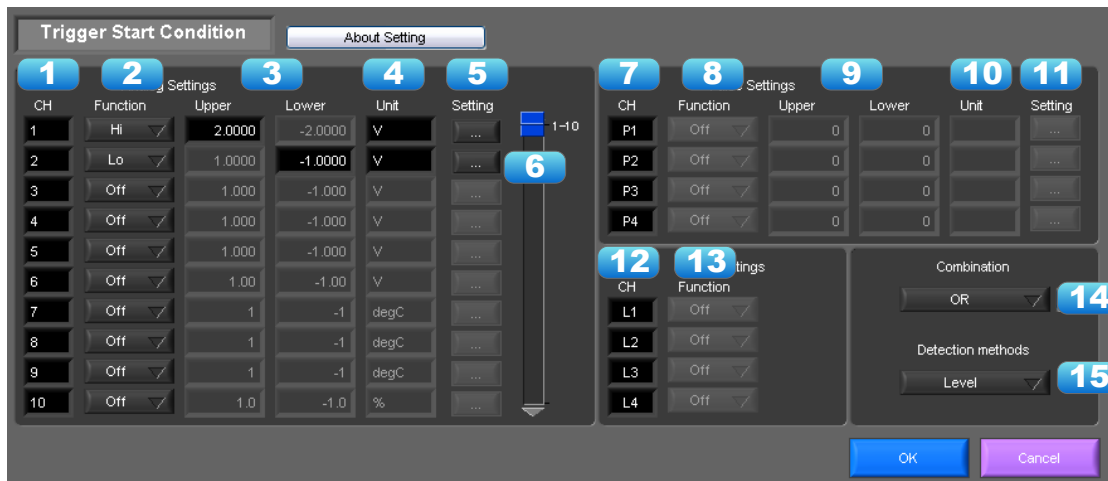

No.	Name	Description										
1	CH switching	Switch channels to be set.										
2	CH	The channel numbers are displayed here.										
3	Function	Use this button to select the trigger level detection mode. <table border="1"> <tr> <td>Off</td> <td>Disabled</td> </tr> <tr> <td>Hi</td> <td>A trigger is generated if the input signal is above the specified level.</td> </tr> <tr> <td>Lo</td> <td>A trigger is generated if the input signal is below the specified level.</td> </tr> <tr> <td>WinIn</td> <td>A trigger is generated if the input signal comes between the specified levels.</td> </tr> <tr> <td>WinOut</td> <td>A trigger is generated if the input signal goes outside the specified levels.</td> </tr> </table>	Off	Disabled	Hi	A trigger is generated if the input signal is above the specified level.	Lo	A trigger is generated if the input signal is below the specified level.	WinIn	A trigger is generated if the input signal comes between the specified levels.	WinOut	A trigger is generated if the input signal goes outside the specified levels.
Off	Disabled											
Hi	A trigger is generated if the input signal is above the specified level.											
Lo	A trigger is generated if the input signal is below the specified level.											
WinIn	A trigger is generated if the input signal comes between the specified levels.											
WinOut	A trigger is generated if the input signal goes outside the specified levels.											
4	Upper/Lower	The level settings are displayed here.										
5	Unit	The unit is displayed here.										
6	Setting	Click this button to make the level settings.										
7	Pulse CH	The channel numbers for pulses are displayed here.										
8	Pulse Function	Use this button to select the pulse level detection mode. (Same as Analog)										
9	Pulse Upper/Lower	The level settings are displayed here.										
10	Pulse Unit	The unit is displayed here.										
11	Pulse Settings	Click this button to make the pulse settings.										
12	Logic CH	The channel numbers for logics are displayed here.										
13	Logic Function	Use this button to select the logic setting. <table border="1"> <tr> <td>Off</td> <td>Disabled</td> </tr> <tr> <td>H</td> <td>Detection is performed when the signal is rising.</td> </tr> <tr> <td>L</td> <td>Detection is performed when the signal is falling.</td> </tr> </table>	Off	Disabled	H	Detection is performed when the signal is rising.	L	Detection is performed when the signal is falling.				
Off	Disabled											
H	Detection is performed when the signal is rising.											
L	Detection is performed when the signal is falling.											
14	Combination	Use this button to set the combination of configured triggers. <table border="1"> <tr> <td>OR</td> <td>Data capture starts (stops) when one of the configured trigger conditions is true.</td> </tr> <tr> <td>AND</td> <td>Data capture starts (stops) when all of the configured trigger conditions are true.</td> </tr> </table>	OR	Data capture starts (stops) when one of the configured trigger conditions is true.	AND	Data capture starts (stops) when all of the configured trigger conditions are true.						
OR	Data capture starts (stops) when one of the configured trigger conditions is true.											
AND	Data capture starts (stops) when all of the configured trigger conditions are true.											
15	Detection methods	Sets the detection method of a trigger. <table border="1"> <tr> <td>Level</td> <td>Each condition is Level operation.</td> </tr> <tr> <td>Edge</td> <td>Each condition is Edge operation.</td> </tr> </table>	Level	Each condition is Level operation.	Edge	Each condition is Edge operation.						
Level	Each condition is Level operation.											
Edge	Each condition is Edge operation.											

7-12-3-3. Trigger Level Settings Screen

This screen is used to make the level settings to detect a trigger. To make the settings, you input numerical values directly or use a cursor.

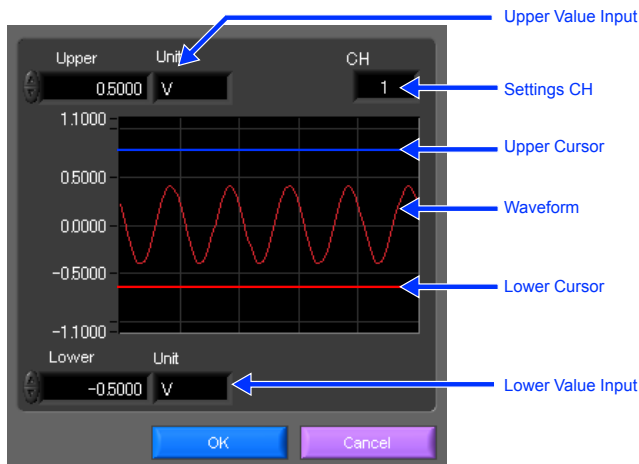

7-12-3-4. Level Detection and Edge Detection

To detect a trigger, you can select level detection or edge detection.

- Level Detection:

In the level detection, a trigger is detected when an input signal is above/below the specified level.

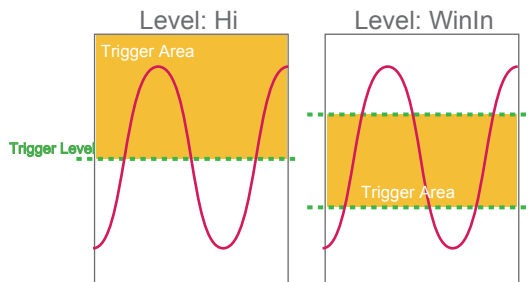

- Edge Detection:

In the edge detection, a trigger is detected when an input signal is above/below the specified level.

Even if an input signal reached the detection level before, a trigger is not detected unless it reaches the level again after it is outside.

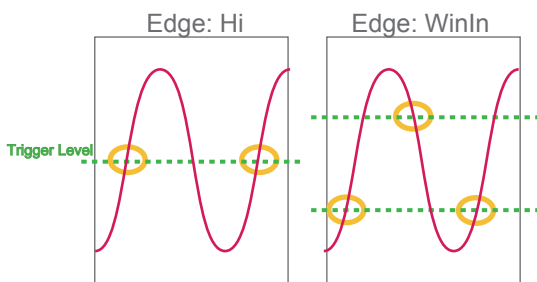

7-12-3-5. Alarm Condition

The alarm level settings for each input are made at this screen.

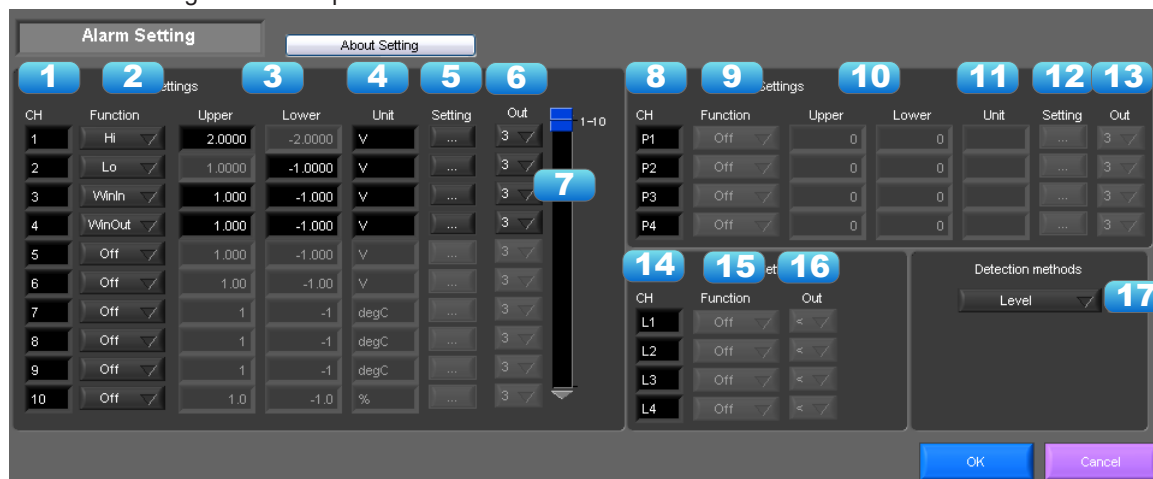

No.	Name	Description	
1	CH switching	Switch channels to be set.	
2	CH	The channel numbers are displayed.	
3	Function	Select the alarm level detection mode.	
		Off	Disabled.
		Hi	An alarm is generated if the input signal is above the specified level.
		Lo	An alarm is generated if the input signal is below the specified level.
		WinIn	An alarm is generated if the input signal comes between the specified levels.
WinOut	An alarm is generated if the input signal goes outside the specified levels.		
4	Upper/Lower	The level settings are displayed here.	
5	Unit	The unit is displayed here.	
6	Setting	Click this button to make the level settings.	
7	Output	Set the terminal that outputs an alarm. It is selected out of the device's four alarm output terminals or the remote sensor (WL1 to WL5, RT1 to RT5). OR is applied to output of the terminal for each channel.	
8	Pulse CH	The channel numbers for pulses are displayed here.	
9	Pulse Function	Use this button to select the pulse level detection mode. (Same as Analog)	
10	Pulse Upper/Lower	The level settings are displayed here.	
11	Pulse Unit	The unit is displayed here.	
12	Pulse Settings	Click this button to make the pulse settings.	
13	Pulse Output	Set the terminal that outputs an alarm. It is selected out of the device's four alarm output terminals or the remote sensor (WL1 to WL5, RT1 to RT5). OR is applied to output of the terminal for each channel.	
14	Logic CH	The channel numbers for logics are displayed here.	
15	Logic Function	Use this button to select the logic setting.	
		Off	Disabled
		H	Detection is performed when the signal is rising.
L	Detection is performed when the signal is falling.		
16	Logic Output	Set the terminal that outputs an alarm. It is selected out of the device's four alarm output terminals or the remote sensor (WL1 to WL5, RT1 to RT5). OR is applied to output of the terminal for each channel.	

No.	Name	Description				
17	Detection methods	Sets the detection method of a alarm. <table border="1"><tr><td>Level</td><td>Each condition is Level operation.</td></tr><tr><td>Edge</td><td>Each condition is Edge operation.</td></tr></table>	Level	Each condition is Level operation.	Edge	Each condition is Edge operation.
Level	Each condition is Level operation.					
Edge	Each condition is Edge operation.					

7-12-4. Report Settings

The daily report and monthly report settings, as well as the Direct to Excel settings, are made at this screen. The daily report and monthly report are created as separate CSV files at capture intervals that are separate from those of the captured data. The Export to Direct Excel File function transfers data in real time to an Excel file as it is being captured. If a template is used for the Excel file, waveforms can also be drawn in Excel in real time.

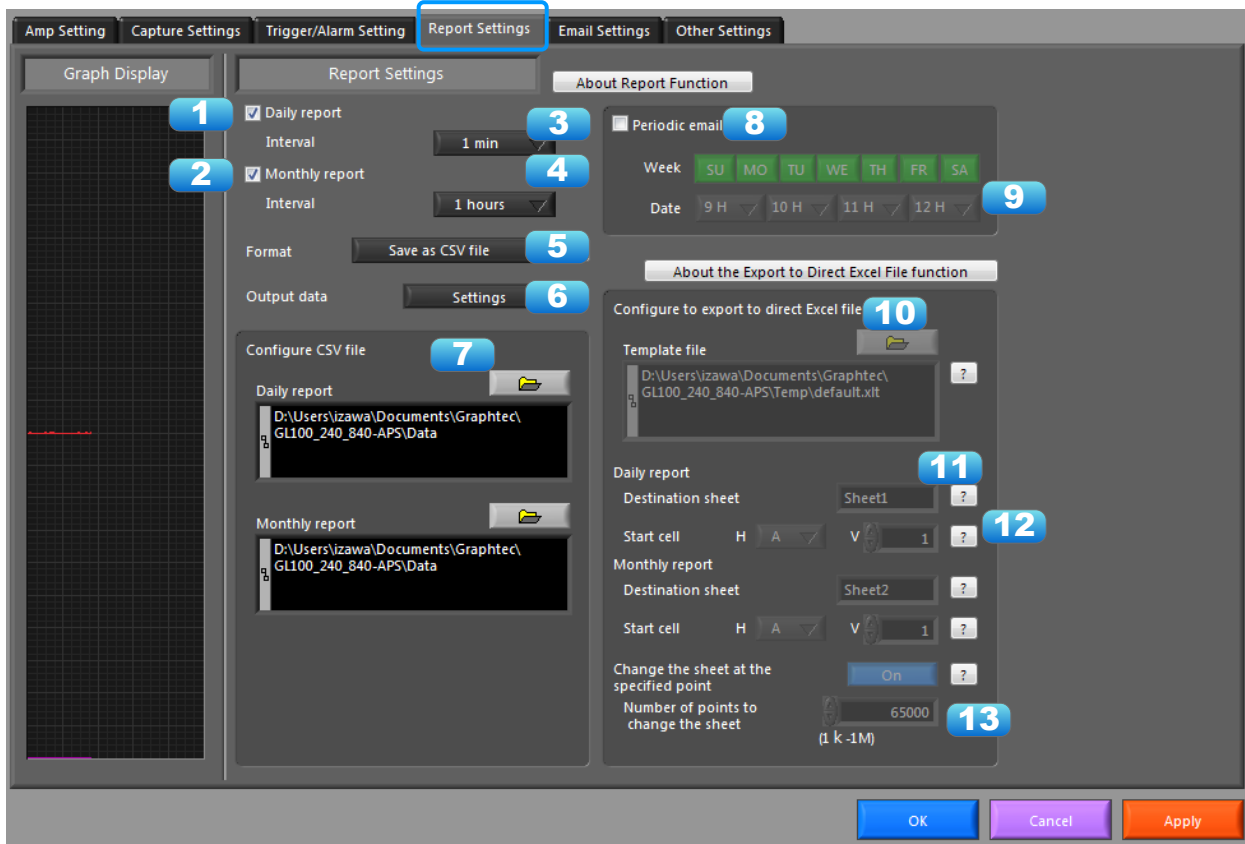

No.	Name	Description				
1	Daily report	Click this checkbox to enter a check and enable the Daily report function.				
2	Monthly report	Click this checkbox to enter a check and enable the Monthly report function.				
3	Daily report Capture Interval	Use this button to select the daily capture interval. 100/200/500(msec)/1/2/5/10/30(sec)/1/5/10/30/60(min). *If a setting that is faster than the recording interval in Recording Configurations is set, data is output at the recording intervals in Recording Configurations. *To perform a statistic calculation, data is output when the recording interval in Recording Configurations matches the daily report. This can be said for the monthly report as well.				
4	Monthly report Capture Interval	Use this button to select the monthly capture interval. Available settings are 1/2/6/12/24hours.				
5	Output Format	Use this button to select the output format for the report(s). <table border="1" style="width: 100%;"> <tr> <td>Save as CSV batch files</td> <td>The data is saved as CSV batch files.</td> </tr> <tr> <td>Export to direct Excel file</td> <td>The captured data is exported directly to Excel. If a template file that was created in Excel is used, an original report can be created in real time. The template files that were provided as standard accessories can also be used. * EXCEL must be installed to use this function. * Transfer of 32000 points or more is disabled if a graph is used in the template. *You need to use an Excel 2007 template to output multiple-channel data that has 256 or more rows.</td> </tr> </table>	Save as CSV batch files	The data is saved as CSV batch files.	Export to direct Excel file	The captured data is exported directly to Excel. If a template file that was created in Excel is used, an original report can be created in real time. The template files that were provided as standard accessories can also be used. * EXCEL must be installed to use this function. * Transfer of 32000 points or more is disabled if a graph is used in the template. *You need to use an Excel 2007 template to output multiple-channel data that has 256 or more rows.
Save as CSV batch files	The data is saved as CSV batch files.					
Export to direct Excel file	The captured data is exported directly to Excel. If a template file that was created in Excel is used, an original report can be created in real time. The template files that were provided as standard accessories can also be used. * EXCEL must be installed to use this function. * Transfer of 32000 points or more is disabled if a graph is used in the template. *You need to use an Excel 2007 template to output multiple-channel data that has 256 or more rows.					
6	Output data	Set output data for reports.				

No.	Name	Description
7	Configure CSV file: Daily/Monthly report	Set the saving destination of daily/monthly report files.
8	Periodic email	Function to send a periodic email at the designated time. Email sent only during recording.
9	Date/Time Settings	Set date and time for sending periodic email.
10	Template file	The template file settings for the Export to Direct Excel File function are made here. Files with the ".xlt" and ".xls" extensions can be used. Template files are provided as standard in the "Temp" folder that is installed with this software.
11	Destination sheet	This parameter is used to specify the name of the specified template sheet.
12	Start cell	This parameter is used to specify the start position on the sheet from which to transfer data.
13	Switch sheet	When the specified number of points is reached, data is transferred to a different sheet. * When data is transferred to a different sheet, the graph or other element may not work correctly. * EXCEL versions before 2007: Supports display up to Row 65536. * EXCEL 2007 and later versions: Supports display up to Row 1048576. * Transfer of 32000 points or more is disabled if a graph is used in the template.

7-12-4-1. Output data configurations

Set output data for reports.

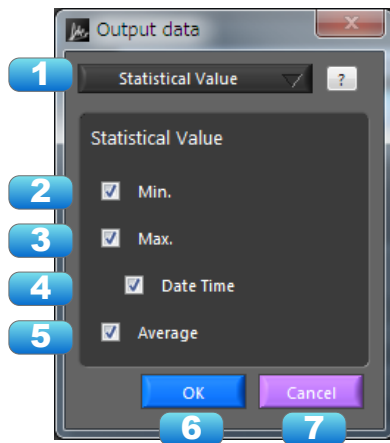

No.	Name	Description				
1	Output data selection	<table border="1"> <tr> <td>Instantaneous Value</td> <td>The instantaneous value per recording interval for daily/monthly reports will be output. *When an instantaneous value is set, alarm data does not include humidity deficit of the temperature/humidity sensor (GS-TH) and calculation data.</td> </tr> <tr> <td>Statistical Value</td> <td>The statistical results that are obtained per recording interval in data configurations will be output at the recording intervals for daily/monthly reports.</td> </tr> </table>	Instantaneous Value	The instantaneous value per recording interval for daily/monthly reports will be output. *When an instantaneous value is set, alarm data does not include humidity deficit of the temperature/humidity sensor (GS-TH) and calculation data.	Statistical Value	The statistical results that are obtained per recording interval in data configurations will be output at the recording intervals for daily/monthly reports.
		Instantaneous Value	The instantaneous value per recording interval for daily/monthly reports will be output. *When an instantaneous value is set, alarm data does not include humidity deficit of the temperature/humidity sensor (GS-TH) and calculation data.			
Statistical Value	The statistical results that are obtained per recording interval in data configurations will be output at the recording intervals for daily/monthly reports.					
2	Min.	The minimum value will be output.				
3	Max.	The maximum value will be output.				
4	Date Time	The time when the minimum value and maximum value occurred will be output.				
5	Average	The average value will be output.				

7-12-5. Email Settings

Can send an email during alarm operation, or send a periodic email.
(Environment required for sending of emails)

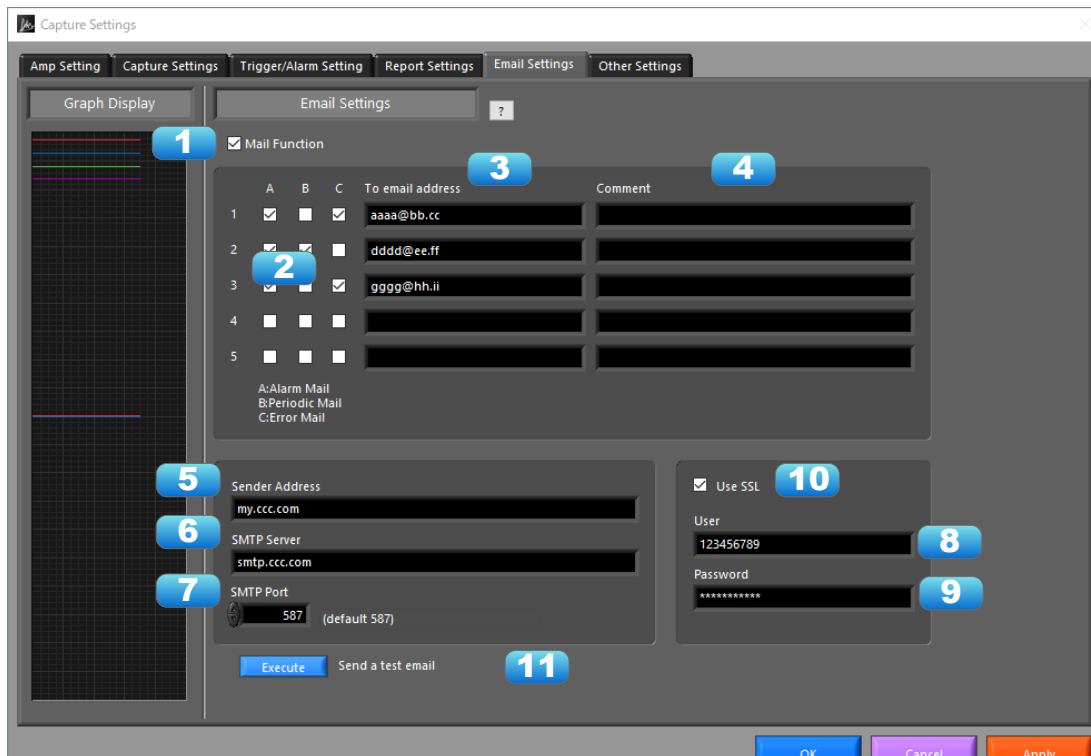

No.	Name	Description
1	Send Email when Alarm is Generated	To send an email when an alarm has been generated, click the checkbox to insert a check
2	On/Off	You can enable/disable alarm mail, recurring mail, and error mail for up to 5 destinations.
3	Address(s)	Enter the email address.
4	Title	Enter the Title.
5	Sender address	Enter the sender email address.
6	SMTP Server	Enter the SMTP server name or address.
7	SMTP Port	Set SMTP server sending port. When not using SSL, 25, when using SSL, 587 or 465
8	User	Input authorized user name for SMTP server
9	Password	Input authorized user name for SMTP server
10	Use SSL/TLS	Input authorized user name for SMTP server
11	Send Test Mail	Send test mail to email address.

EX) When sending to Gmail (as of April 2023)

SMTP server	smtp.gmail.com
SMTP port	587
User	Account Name at Gmail
Password	Password for Gmail account This is the password generated with the 2-step verification process enabled through the authentication change.
Use SSL/TLS	On

● CHECKPOINT

The mail send function is available only during capture. No mail is sent even if an alarm is generated during the Free Running status.

7-12-6. Other Settings

This screen is used to make various other settings and to display information.

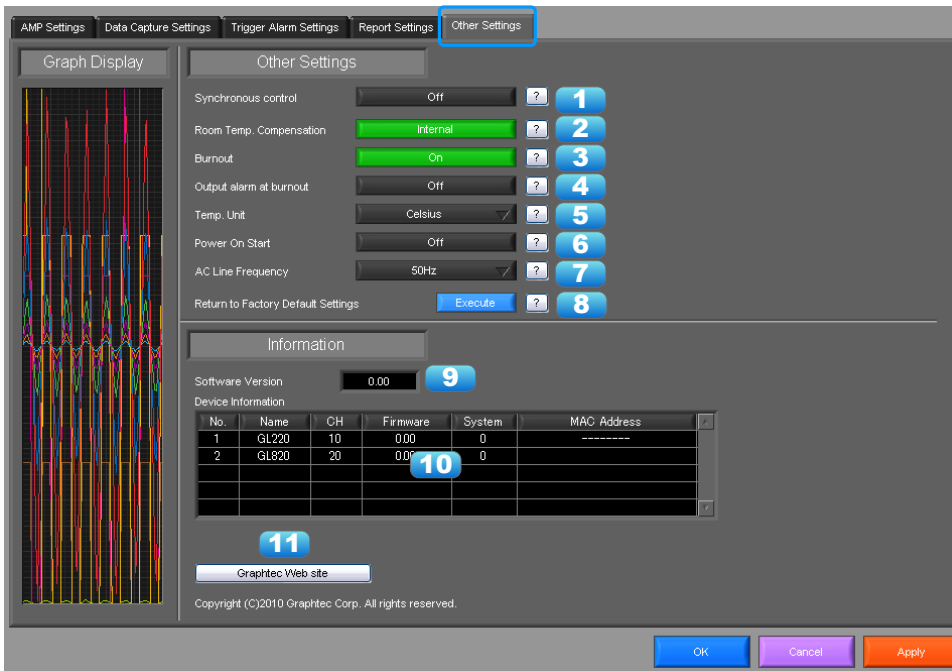

No.	Name	Description
1	Room Temp. Compensation	This parameter is used when thermocouples are used to perform temperature measurement. When using this device for room temperature compensation, select Internal.(Always select Internal for this setting.)
2	Burnout	Set to On to regularly check a thermocouple sensor line break. If a thermocouple is connected parallel with other measurement devices, please set this to Off as it may affect the other devices. When a sensor line break is detected, "BURNOUT" message appears.
3	Temp. Unit	The display unit can be switched between Celsius and Fahrenheit.
4	Power On Start	Data capture starts automatically as soon as the power to the device is turned on. This setting can only be specified for data capture to the device. If On has been selected, select "Save the settings to the device" when exiting this software.
5	AC Line Frequency	Set the voltage frequency to suit the area where the device will be used. Be sure to select the correct frequency, as an incorrect setting affects the noise reduction capability. Refer to the instruction manual of the main unit for the sampling speed at which noise in the power supply can be eliminated.
6	Return to Factory Default Settings	Click this button to return the settings to the default values.
7	Software Version	The software version is displayed here.
8	Device Information	Information relating to the connected device is displayed here.
9	Graphtec Web site	Click this button to access the GRAPHTEC web site.

7-13. FILE menu

The FILE menu provides replay, CSV conversion, printing, and screen saving of captured data.

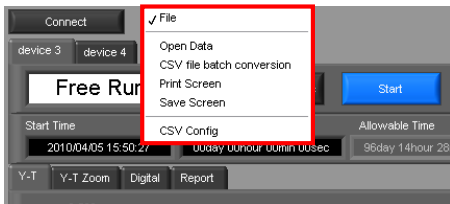

7-13-1. Open File

Replays data captured to the PC or GL device unit. Select "Open File" to open the file selection screen (See figure below). Select a file to be replayed.

*Please do not use alphanumeric characters other than the folder and file names. Can not read the file correctly.

*CSV data recorded in the main unit cannot be played back directly. Please remove the SD memory card from the main unit and insert it into your PC, or copy the files once to a disk on your PC.

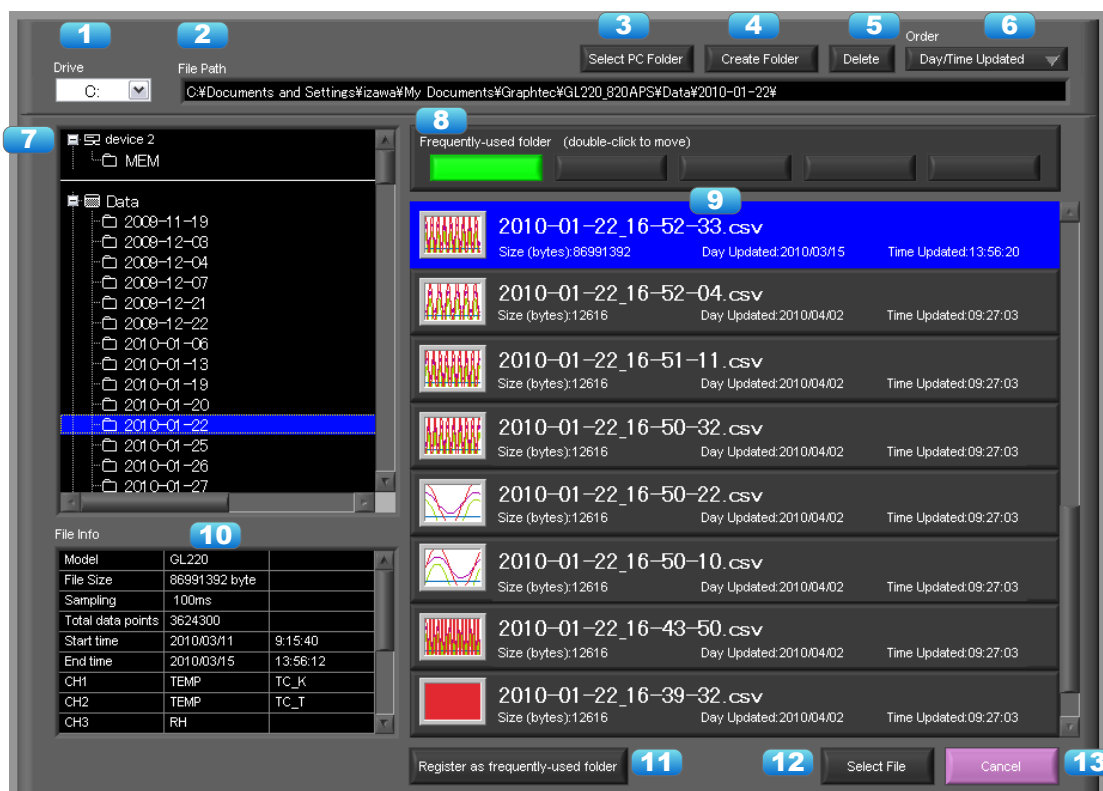

No.	Name	Description
1	File Chart	You can check the captured data files in the PC by timeline with this file chart. Data files in the device cannot be displayed.
2	Drive	Use this button to select the appropriate PC drive.
3	File Path	The file location is displayed here.
4	Select Folder	Click this button to select the folder that has data files.
5	Create Folder	Click this button to create a new folder.
6	Delete	Click this button to delete the selected file.
7	Order	Use this button to select the file arrangement order.
8	File Tree	The hierarchies of the device are displayed in a tree format. The "Data" is the default location to save files in this application. This is the APS folder in the user document folder.
9	Frequently-used folder	Use these buttons to select a frequently-used folder and move the file to that folder. Single click : Select Double click : Move.
10	File List	Files/folders in the current hierarchy are displayed.

11	File Information	When you select binary or text data in the current hierarchy, file information is displayed.
12	Device Files Transfer	The files in the device will be transferred to the PC. Multiple files can be transferred.
13	Select File	Click this button to select a file (display the file).
14	Cancel	Click this button to cancel the selected file.

Refer to "Replay Screen" for details on data replay.

7-13-1-1. File Chart

You can check the captured data files in the PC by timeline with this file chart. Data files in the device cannot be displayed.

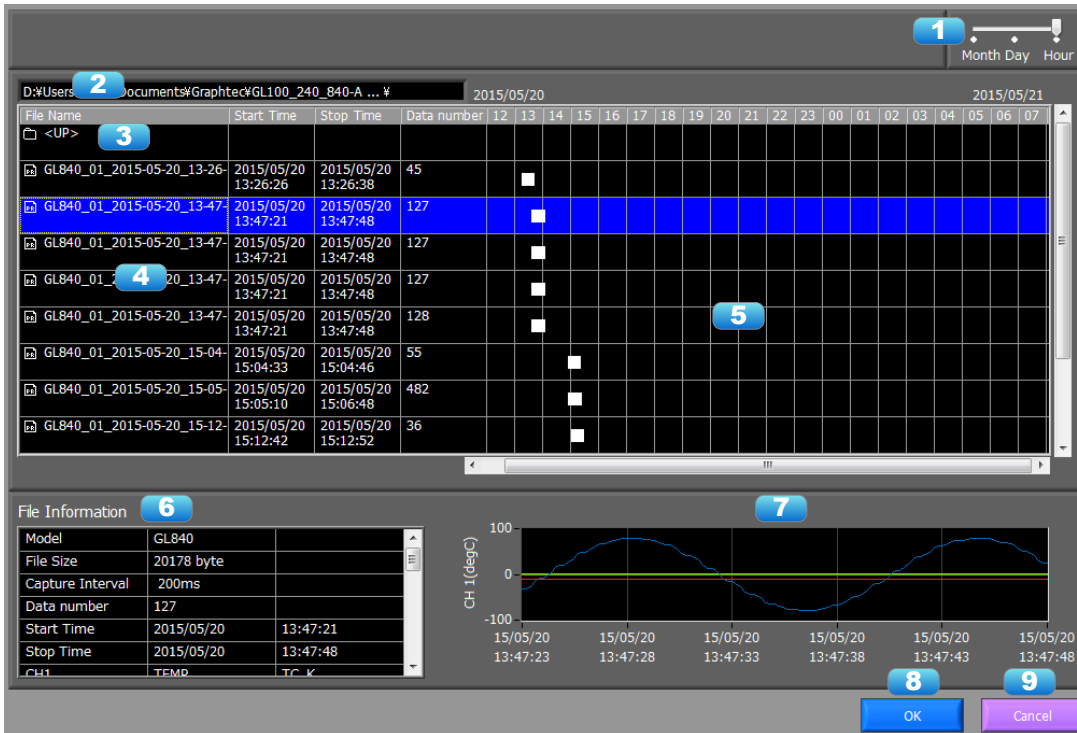

No.	Name	Description
1	Time Axis Switching	Changes the time axis to display the chart.
2	File Path	Displays the file path currently opened.
3	An Upper Folder	Double-click to move to an upper folder.
4	File List	Displays the file list.
5	Chart display	Displays the chart of the set term at time axis switching.
6	File Information	Displays the file information of the selected file. (only GBD and CSV files)
7	Simple Waveform Display	The waveform of the data selected in the file list will be simply displayed.
8	OK	The selected file will be opened.
9	Cancel	Cancel the file selection.

7-13-1-2. Device Files Transfer

Data in the device is transferred to the PC. By selecting multiple files in the screen to open data, multiple files will be able to be transferred. To select multiple files, select multiple files by pressing the CTRL key or SHIFT key.

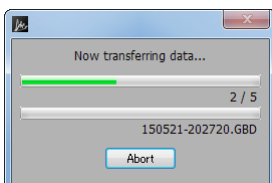

7-13-2. File History

Files opened, captured, and converted in the past will be listed as log and can be played.

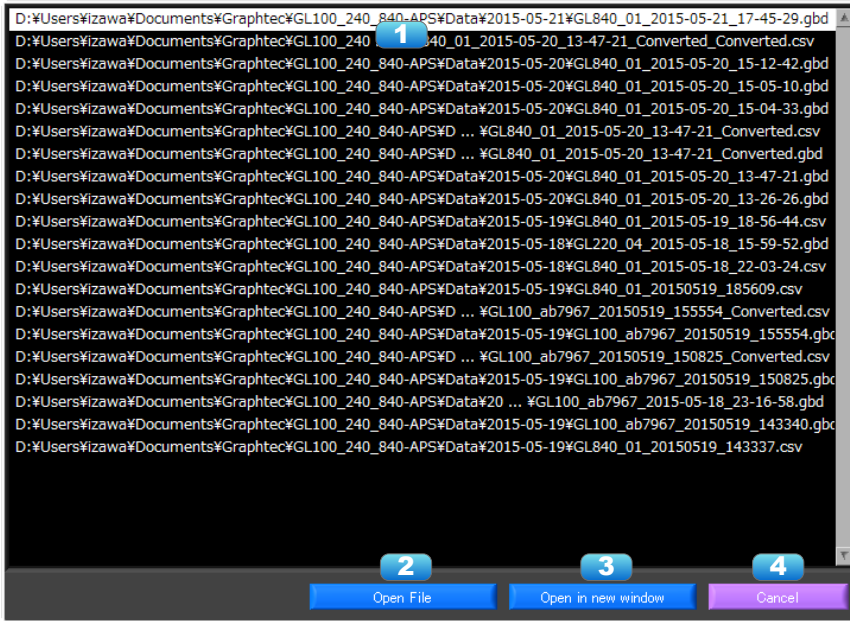

No.	Name	Description
1	Log List	Displays the log list.
2	Open File	Opens the file selected in the log list.
3	Open in new window	Opens the file selected in the log list in a new window.
4	Cancel	Closes the window without any action.

7-13-3. CSV File Batch Conversion

This function enables multiple GBD (binary data) files to be converted in a batch to CSV format files.

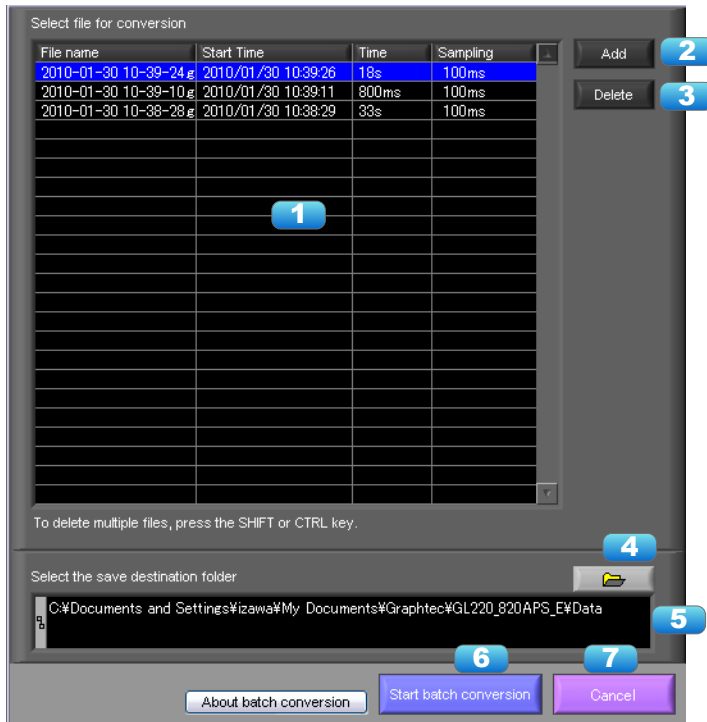

No.	Name	Description
1	List of converted files	The batch-converted files are displayed in a list.
2	Add	Click this button to add a file to the batch to be converted.
3	Delete	Click this button to remove a file from the batch to be converted. With the SHIFT or CTRL key pressed, you can select more than one file.
4	Scaling Settings	Performs scaling (conversion of units) to a file subject to conversion. Configure settings in relation to the topmost file in the list. Scaling will be reflected onto the second file and thereafter in cases when such files have the same conditions as the first file. Scaling will not be performed in relation to files for which conditions differ. The conditions are as follows: - The number of channels, inputs, and ranges of the analog channels (including GS sensors) are identical - The number of channels, and inputs of the pulse channels (including GS sensors) are identical - The existing scaling settings are identical
5	Save destination folder	Select the save destination for the batch-converted files here.
6	Save folder path	Displays the path of the save folder.
7	Start batch conversion	Click this button to start batch file conversion.
8	Cancel	Click this button to cancel the batch conversion operation and close the screen.

7-13-4. Print Screen

Prints the display screen on the printer. Printing is performed at the printer that has been selected as the default printer. If you change the printer, relaunch the software.

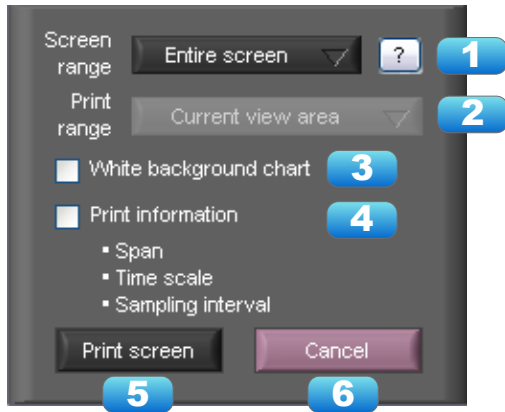

No.	Name	Description	
1	Screen range	Select a screen range to be printed.	
		Entire screen	Prints all of the displayed screen.
		Waveform only	Prints only the waveform graph.
2	Print range	Selects a range to be printed. * Selection is available when the scroll is Off during capture, or during data replay.	
		Current view area	Prints the current view area.
		Between the cursor A and B	Prints data between Cursors A and B in the time scale in which it is displayed. If the range is too large, data is printed on more than one sheet.
3	White background chart	Prints the waveform graph against a white background.	
4	Print information	Prints the graph with information in it. The information to be printed is the span, Time/DIV, and sampling interval. Not all the channel information may be included depending on the number of channels to be displayed.	
5	Print	Starts printing.	
6	Cancel	Cancels printing.	

7-13-5. Save Screen

To save the displayed screen as a BMP file.

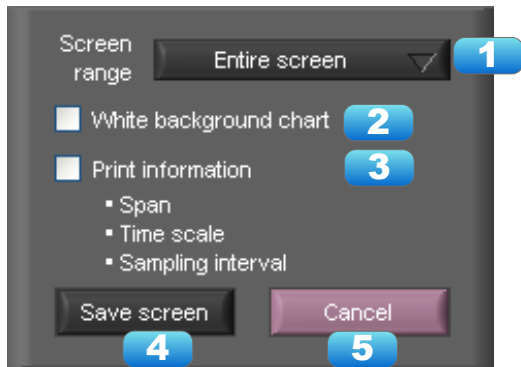

No.	Name	Description	
1	Screen range	Selects a range of the screen to be saved in BMP.	
		Entire screen	Saves all the displayed screen in BMP.
		Waveform only	Saves only the waveform graph in BMP.
2	White background chart	Saves the waveform graph against a white background in BMP.	
3	Print information	Saves the graph with information displayed in it in BMP. The information to be displayed is the span, Time/DIV, and sampling interval. * Not all the channel information may be included depending on the number of channels to be displayed.	
4	Save	Starts saving the screen in BMP.	
5	Cancel	Cancels saving the screen.	

7-13-6. Other Settings

With Other Settings, power charge settings, cumulative temperature unit settings, and CSV settings can be configured. This setting is for the decimal point and the delimiter that are used in the CSV file for output.

Please set according to the setting of OS that actually used.

The CSV file which uses different decimal point and delimiter cannot be opened.

Electricity rate setting and integrated temperature unit setting are applicable only to GL240 and GL840.

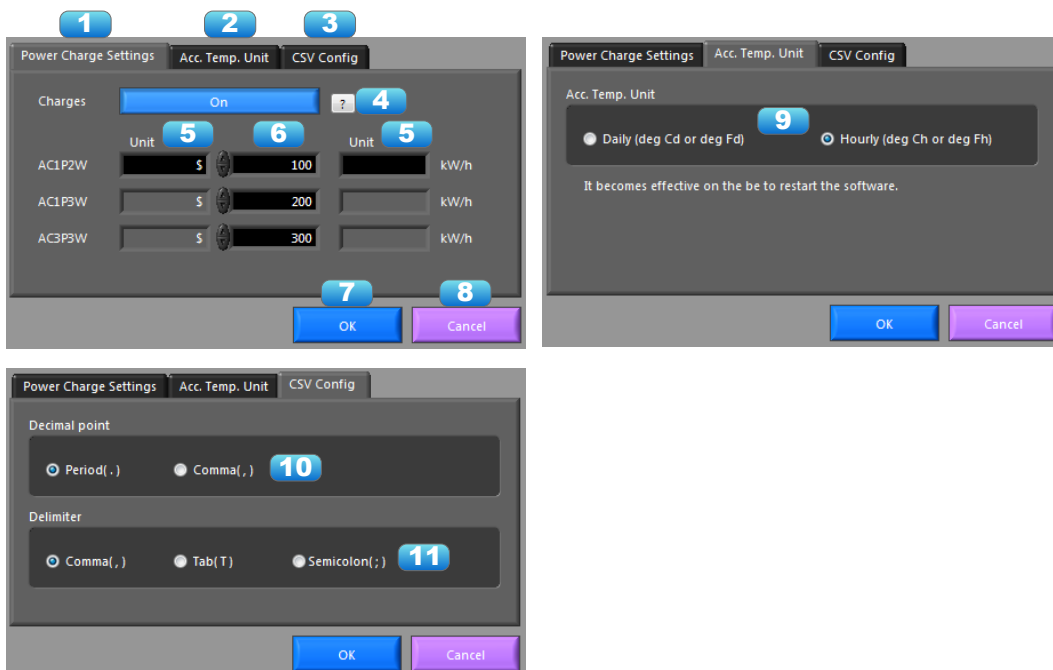

No.	Name	Description				
1	Power Charge Settings	Configures the unit price for charges used to calculate power charges based on the cumulative amount of power. As these settings are also recorded in the recording file (GPower Charge SettingsBD/CSV), upon playback of the recording file, the charges will be calculated based on this information saved in the file.				
2	Accumulated Temperature Units	Configures the units for the accumulated temperature CH of the temperature and humidity sensor (GS-TH). The software will need to be restarted for the settings to be reflected.				
3	CSV Settings	Configures the character used for the decimal point and delimiter in CSV data.				
4	On/Off	Switch this On to display the charges. The switching between On/Off will be immediately reflected on the screen.				
5	Charge Units	Configures the units for charges. Up to four single-byte characters can be configured. Units can be configured to each before and after the charges. Examples: \$123, 123 yen				
6	Charge Unit Price	Configures the unit price per kWh. A unit price can be configured for each clamp mode.				
7	OK	Reflects the settings.				
8	Cancel	Cancel the settings.				
9	Accumulated Temperature Units	<p>Configures the units for the accumulated temperature CH of the temperature and humidity sensor (GS-TH). The software will need to be restarted for the settings to be reflected.</p> <table border="1"> <tbody> <tr> <td>1-day units (deg C or F /d)</td> <td>Data will be displayed in units of single days.</td> </tr> <tr> <td>1-hour units (degC or F /h)</td> <td>Data will be displayed in units of single hours.</td> </tr> </tbody> </table> <p>*The software will need to be restarted for the settings to be reflected. *When set to degC/d or degF/d, recording file is saved in the degC/h or degF/h, it will be displayed in degC/d or degF/d during playback.</p>	1-day units (deg C or F /d)	Data will be displayed in units of single days.	1-hour units (degC or F /h)	Data will be displayed in units of single hours.
1-day units (deg C or F /d)	Data will be displayed in units of single days.					
1-hour units (degC or F /h)	Data will be displayed in units of single hours.					
10	Decimal Point	Configures the character used for the decimal point in CSV data.				
11	Delimiter	Configures the character used as a delimiter in CSV data.				

● NOTE

Please set to the delimiter other than the comma (,) if the comma (,) is set to the decimal point.
Do not set comma (,) to both the decimal point and the delimiter at same time.

7-14. Replay Data

This section explains how to replay data that has been captured.

7-14-1. Y-T

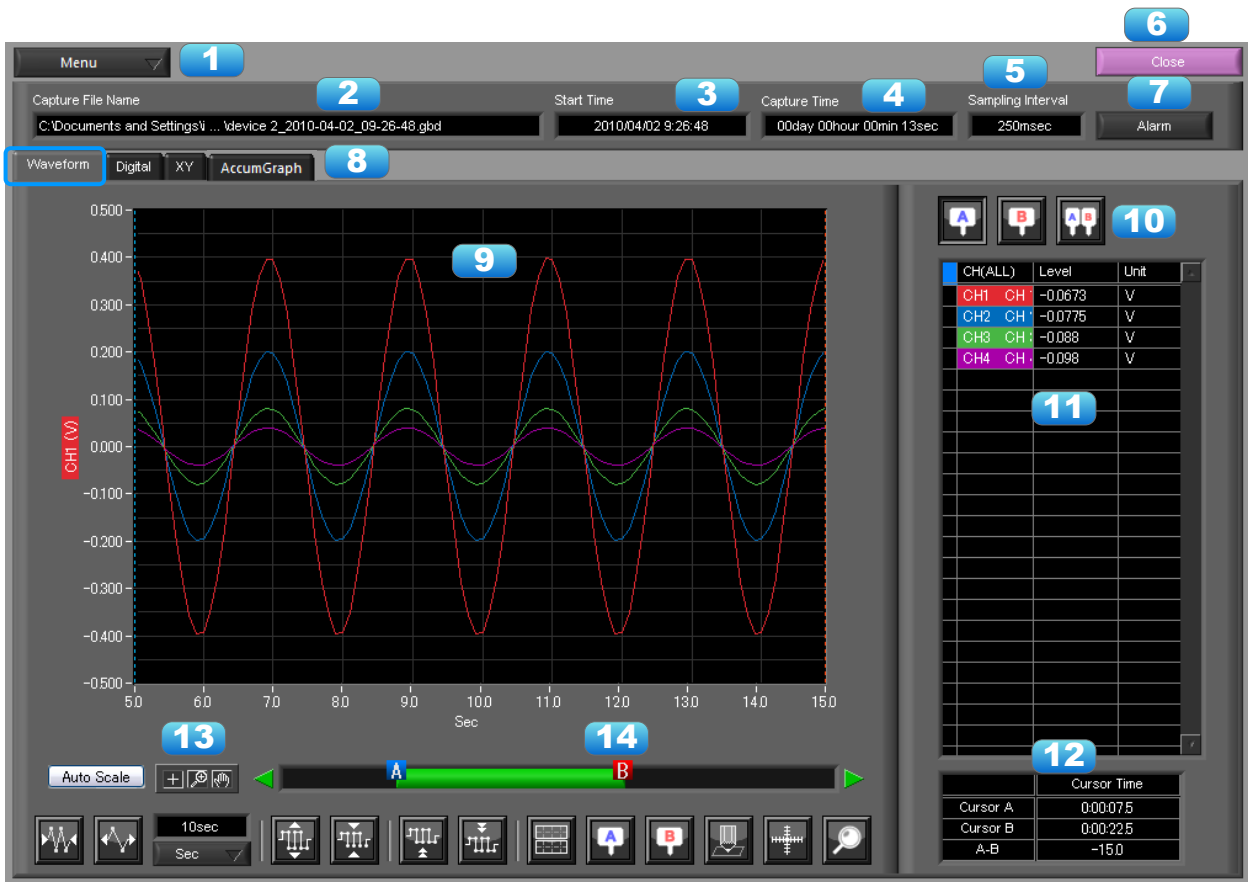

No.	Name	Description	
1	File	Operations related to files are performed.	
		Open File	Click this button to open the screen for opening files captured to a PC or to the device.
		Open in new window	Opens a file in a new window. This function is useful when you compare captured waveforms.
		File History	Files opened, captured, and converted in the past will be listed as log and can be played.
		Superimpose/Link	For the reviewing data, you can overwrite the waveform of other captured data or link and display the waveform.
		Convert then Save	Click this button to convert data being replayed into GBD or CSV files and save them. Data cannot be saved during Free Running.
		Print Screen	Click this button to print out a copy of the displayed screen. Printing is performed at the printer that has been selected as the default printer. If you change the printer, set the printer and then restart the software.
		Save Screen	Click this button to save the displayed screen as a BMP file.
		Scaling Settings	Configures scaling (conversion of units) to a GBD (binary) file that has already been recorded. *Configurations cannot be made for CSV files.
	Other Settings	Configures power charge settings and CSV settings.	
2	Capture File Name	The name of the data capture file that is being replayed.	

3	Start Time	The time at which data capture was started.
4	Capture Time	The data capture time
5	Sampling Interval	The sampling interval * EXT is displayed during external sampling.
6	Close	Click this button to close the replay screen.
7	Alarm	Displays the status of the alarm port on Cursor A.
8	Display switch	Switches display modes. Refer to the page on each of the display modes for details.
9	Waveform Graph	The waveforms are displayed here.
10	Cursors	Selects which of the cursor values should be displayed in the digital display area. Up to three values (Cursor A, Cursor B, Cursor A-B) can be displayed at the same time.
11	Digital	The digital values are displayed in this area. Clicking on any of the CH numbers enables the waveform for that channel to be hidden/displayed. The channels for which an alarm has been generated are shown in red.
12	Cursor Time	The cursor times are displayed during data capture when Scroll Off has been selected.
13	Scale operations	Click this button to perform various settings for the waveform display.
14	Scroll bar	Moves waveform. Can also move Cursors A and B.

● NOTE

Regarding displaying waveform to the screen. This software is trimming the data for high-speed displaying when the waveform is displaying to the screen. Therefore the high response of waveform will not be displayed on the screen when the waveform is displaying by expanding or reduction. This depends on expanded or reduction ratio. Expand the waveform displaying until the high response of waveform is displayed on the screen when the high response of waveform is not displayed on the screen.

7-14-2. Digital

You can select "Digital" tab to switch to the digital display.

The Digital screen is used mainly to perform operations such as statistical calculation using the A and B cursors.



No.	Name	Description
1	Waveform Graph	The waveforms are displayed here.
2	Digital display	The cursor A and B levels, calculation results, and so forth are displayed here.
3	Execute Stat. Calc	Click this button to perform statistical calculation of the data between Cursors A and B.
4	Cursor Time	The cursor A and B times are displayed here.

● NOTE

Regarding displaying waveform to the screen, This software is trimming the data for high-speed displaying when the waveform is displaying to the screen. Therefore the high response of waveform will not be displayed on the screen when the waveform is displaying by expanding or reduction. This depends on expanded or reduction ratio. Expand the waveform displaying until the high response of waveform is displayed on the screen when the high response of waveform is not displayed on the screen.

7-14-3. XY

This function is used to display the data between the A and B cursors in an XY format. (Max 10000 points)

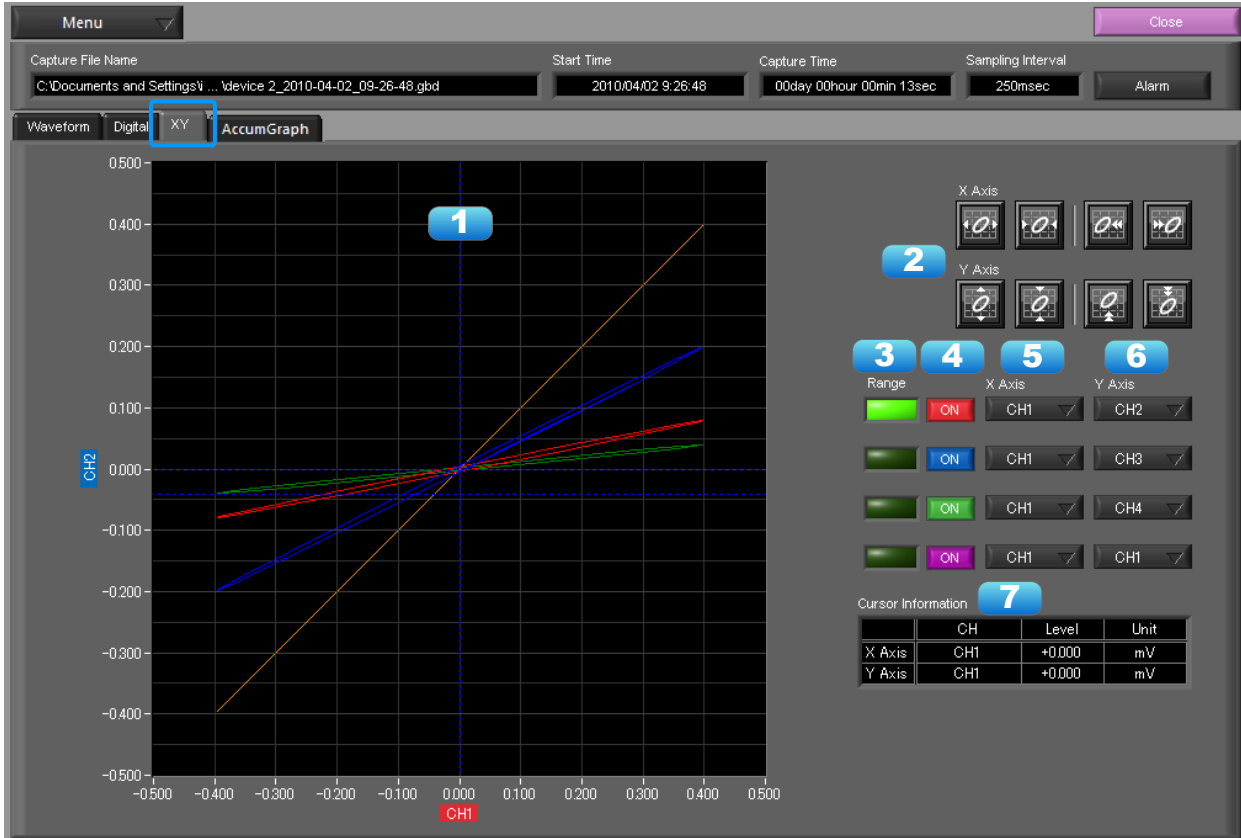

No.	Name	Description
1	X-Y Waveform Graph	The X-Y waveform graph is displayed here.
2	Waveform operation icons	Use these buttons to expand, shrink, or move X and Y axes.
3	Range	These buttons specify display of the scale values for the channels selected for the X and Y axes.
4	On/Off	Click these buttons to specify the display as ON or OFF.
5	X Axis	Use these buttons to select the channels for the X axes.
6	Y Axis	Use these buttons to select the channels for the Y axes.
7	Cursor Information	The cursor levels of the channels for which Range has been specified are shown here.

7-14-4. Accumulated Graph

Accumulated graphs can be displayed if accumulated data of the temperature and humidity sensor (GS-TH), luminance and UV ray sensor (GS-LXUV), or power sensor (DPA-AC) has been recorded in the recorded data file (GBD/CSV). Refer to "7-11-1. Accumulated Graph Display" for details regarding the Accumulated Graph screen. GL240 and GL840 only

7-14-4-1. Accumulated Graph Display

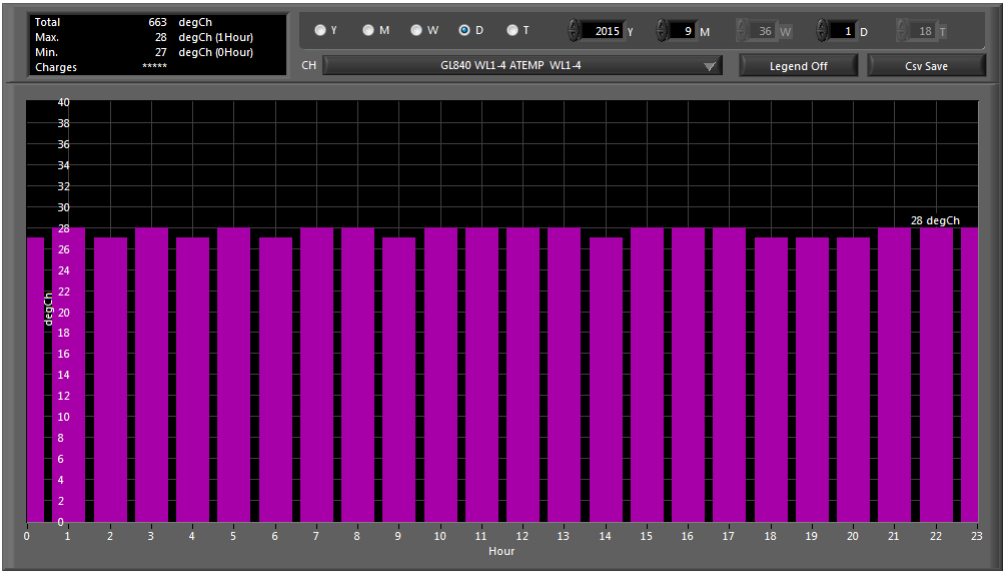

7-14-4-2. Accumulated Integration Graph Display

When multiple files are layered with the superimpose function of the Superimpose/Link function, identical accumulated data will be detected to automatically generate an integration graph.



7-14-5. Superimpose/Link

This function enables multiple files to be superimposed on the display, or to be linked. The data must be captured under the same conditions to be linked. GBD format only support.

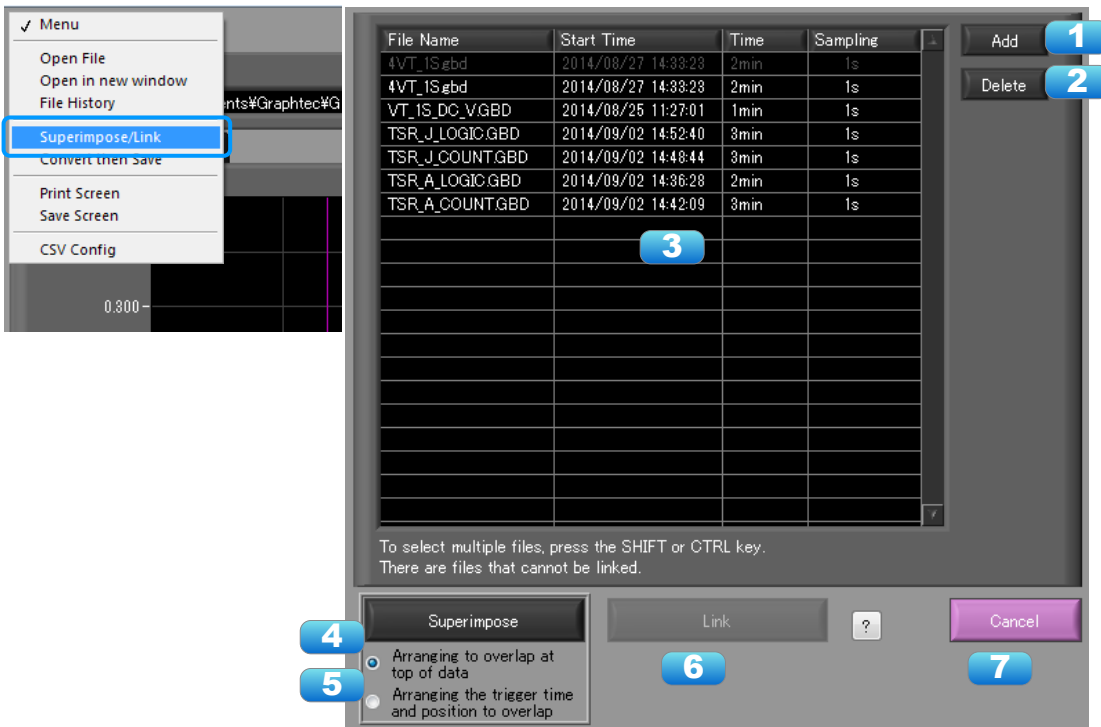

No.	Name	Description				
1	Add	Click this button to add a file to those selected for the superimposing or linking operation. GBD format only support.				
2	Delete	Click this button to delete the added file from the list. With the SHIFT or CTRL key pressed, you can select more than one file.				
3	File List	The files added to those selected for superimposing or linking are listed here.				
4	Superimpose	Click this button to superimpose files. (* Overlapped data cannot be saved.)				
5	Link method	Select link method <table border="1" style="width: 100%;"> <tbody> <tr> <td>Arranging to overlap at top of data</td> <td>Overlapping at top data position</td> </tr> <tr> <td>Arranging the trigger time and position to overlap</td> <td>Overlapping display of trigger time and position. Files with a large time difference cannot be superimposed.</td> </tr> </tbody> </table>	Arranging to overlap at top of data	Overlapping at top data position	Arranging the trigger time and position to overlap	Overlapping display of trigger time and position. Files with a large time difference cannot be superimposed.
Arranging to overlap at top of data	Overlapping at top data position					
Arranging the trigger time and position to overlap	Overlapping display of trigger time and position. Files with a large time difference cannot be superimposed.					
6	Link	Click this button to link files. * Data with different capture conditions cannot be concatenated. When chain the files, the date and time for chained file is displayed based on the date and time of No. 1 file. Therefore the date and time which are for No. 2 and later files may not be same as actual measurement date and time.				
7	Calcel	Click this button to close the screen.				

7-14-6. Convert then Save

This function is used to convert replayed data to a different format (GBD, CSV), and to clip and save only the data between the cursors.

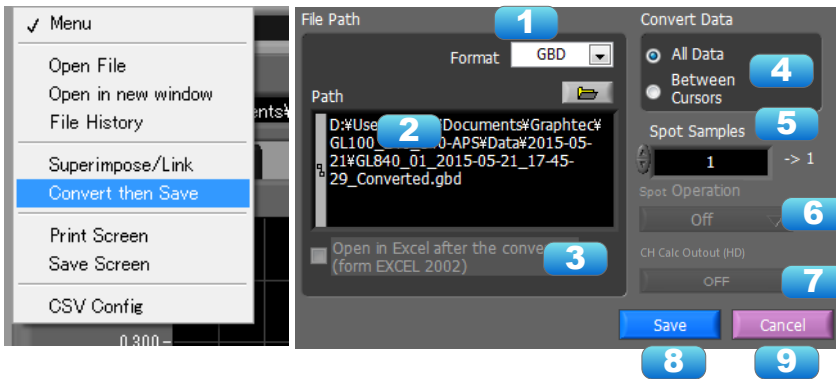

No.	Name	Description								
1	Save format	Select a format to convert and save data. <table border="1"> <tr> <td>GBD</td> <td>binary data * CSV data cannot be converted to binary data.</td> </tr> <tr> <td>CSV</td> <td>text data. This is a file format that can be opened with Microsoft's EXCEL and other software.</td> </tr> </table>	GBD	binary data * CSV data cannot be converted to binary data.	CSV	text data. This is a file format that can be opened with Microsoft's EXCEL and other software.				
GBD	binary data * CSV data cannot be converted to binary data.									
CSV	text data. This is a file format that can be opened with Microsoft's EXCEL and other software.									
2	Path	Select a location to which you want to save data.								
3	Open with EXCEL after the conversion	If this setting is selected, a file converted into CSV format is opened with EXCEL. * This setting cannot be selected if data is saved in binary format. * EXCEL must be installed to use this function. * This function is not available with EXCEL 2000 or any previous versions.								
4	Select data to be converted	<table border="1"> <tr> <td>All Data</td> <td>All of the data being replayed is saved.</td> </tr> <tr> <td>Between Cursor</td> <td>Data between cursors A and B is saved.</td> </tr> </table>	All Data	All of the data being replayed is saved.	Between Cursor	Data between cursors A and B is saved.				
All Data	All of the data being replayed is saved.									
Between Cursor	Data between cursors A and B is saved.									
5	Spot Samples	Spot samples are extracted when saving data. Ex) 1 → 1 :Spot samples are not extracted. Ex) 2 → 1 :One of two data points is extracted.								
6	Spot Interpolation Process	Sets the interpolation process of the spot data, when the spot interval is set to 2 or more. <table border="1"> <tr> <td>Off</td> <td>Spotting will be performed without interpolating.</td> </tr> <tr> <td>AVE</td> <td>Spot data will be interpolated to the average value.</td> </tr> <tr> <td>MAX</td> <td>Spot data will be interpolated to the maximum value.</td> </tr> <tr> <td>MIN</td> <td>Spot data will be interpolated to the minimum value.</td> </tr> </table>	Off	Spotting will be performed without interpolating.	AVE	Spot data will be interpolated to the average value.	MAX	Spot data will be interpolated to the maximum value.	MIN	Spot data will be interpolated to the minimum value.
Off	Spotting will be performed without interpolating.									
AVE	Spot data will be interpolated to the average value.									
MAX	Spot data will be interpolated to the maximum value.									
MIN	Spot data will be interpolated to the minimum value.									
7	CH Calc Output (HD)	When inter-CH calculation has been enabled, switching this On will include inter-CH calculation results in the saved data. This feature is only available when the save format is CSV. Note that even in cases when data of the temperature and humidity sensor (GS-TH) is included, saturation deficit data will also be included and saved. *Performing an output will restructure the order of channels.								
8	Save	Executes conversion and saving.								
9	Cancel	Click to close the screen.								

7-14-7. Scaling Settings

Performs scaling (conversion of units) to a GBD (binary) file. It is also possible to change a CH to which scaling has already been configured. Scaling cannot be configured in relation to the following CH:

- Humidity data
- Cumulative temperature data, cumulative luminance data, cumulative UV ray data, cumulative power data
- Logic data

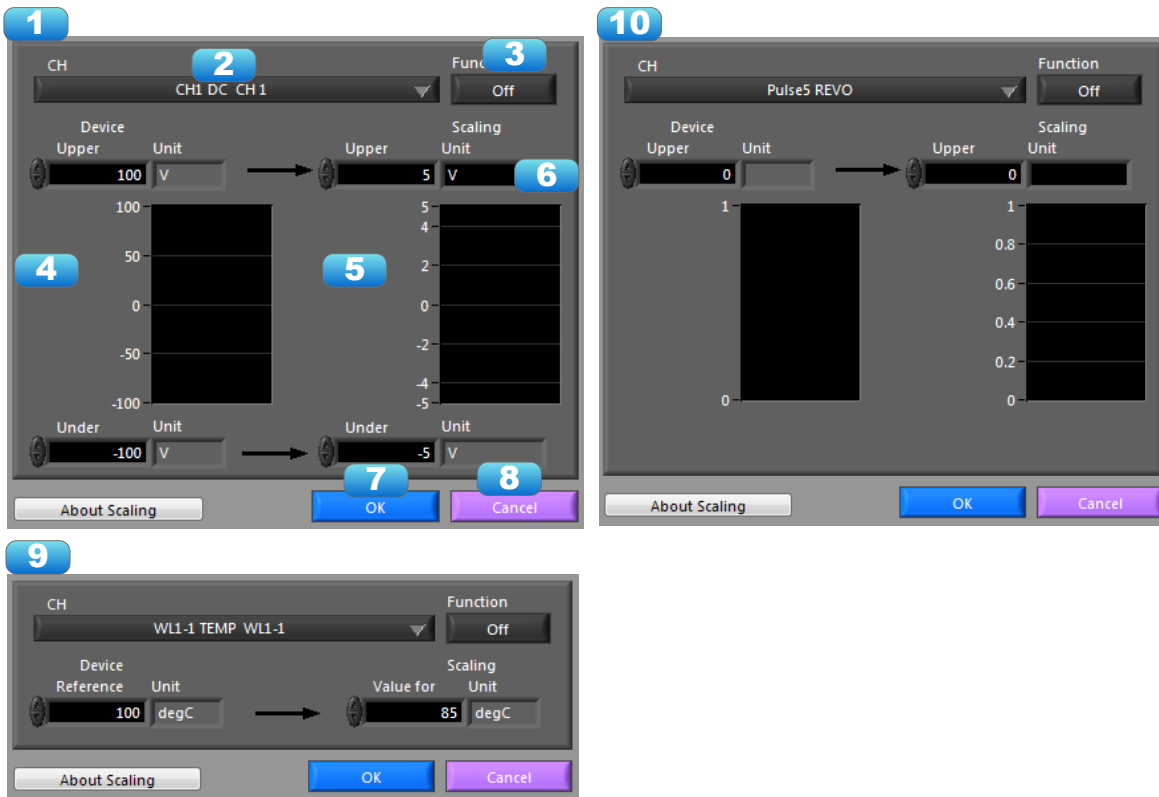

No.	Name	Description
1	Scaling Screen during Analog CH	The scaling screen during analog CH.
2	CH Select	Selects the channel.
3	On/Off	Configures the On/Off of scaling (conversion of units).
4	Measurement Value Limit Settings	Configures the upper value and lower value for measurement value limits.
5	Scaling Limit Settings	Configures the upper value and lower value for the scaling limits.
6	Scaling Limit Units	Configures the units for the scaling side. A maximum of eight single-byte characters can be input.
7	OK	Reflects the settings.
8	Cancel	Cancels the settings.
9	Scaling Screen during Temperature CH	The scaling screen during temperature CH. Perform offset adjustment with a standard value and an adjustment value. Example) When the standard value is 0 degC and the adjustment value is 10 degC, set the temperature value to +10 degC
10	Scaling Screen during Pulse CH	The scaling screen during pulse CH.

7-14-8. Other Settings

Refer to "7-13-6. Other Settings" for details regarding the Other Setting screen.

7-14-9. Scale Operations

Use this area to perform scale operations, enlarge the selected area, etc.

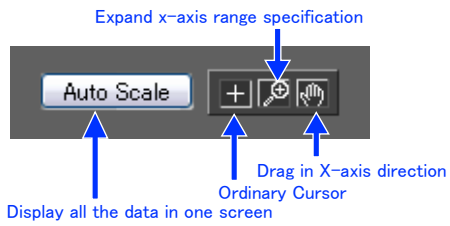

7-14-10. Scroll bar

Allows you to move waveforms and cursors.

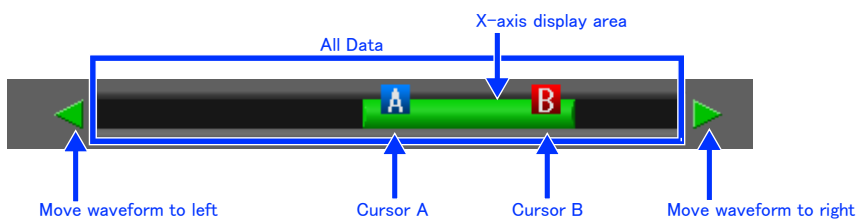

7-15. Other Functions

7-15-1. Alarm

The alarm output port status is displayed in this screen.

During replay, it shows the alarm output port status at the cursor point selected in the digital value display.

Alarm output port numbers differs by the model.



No.	Name	Description
1	1 - 4	Device alarm
2	WL1 - WL5	Alarm on GL100 remote. (GL240, GL840 only)
3	RT1 - RT5	Alarm on GLT400 remote connected to GL840.

7-15-2. About Icons

Y-T View (Y-T Zoom) provides control icons that allow you to perform intuitive operations. Each of the icons has the following functions:



No.	Name	Description
1	Expand/Shrink Time axis	Expands/Shrinks the time axis.
2	Display	Uses the display width of one screen to display time.
3	Expand/Shrink Y axis span	Expands/Shrinks the Y axis of the selected channel.
4	Move Y axis position	Click this icon to move up and move down the Y axis position for the selected channel.
5	Waveform Operation	Click this icon to open the screen to edit graph waveforms.
6	Displays Cursor	Displays Cursor A/B in the waveform display.
7	Comment	Allows you to enter a comment on a waveform of a desired channel during capture or replay. The entered comment will be redisplayed when the file is opened again.
8	Cursor direction switching	Switches the vertical and horizontal sides of a cursor.
9	Move/Search	During replay, click this icon to open the screen to move to the desired time or points and to search at any level.
10	Switch Scale	Click this icon to switch between a relative time and an absolute time. * Disables selection of absolute time in Free Running status.

7-15-2-1. Waveform Operation

Various types of waveform operations can be performed.

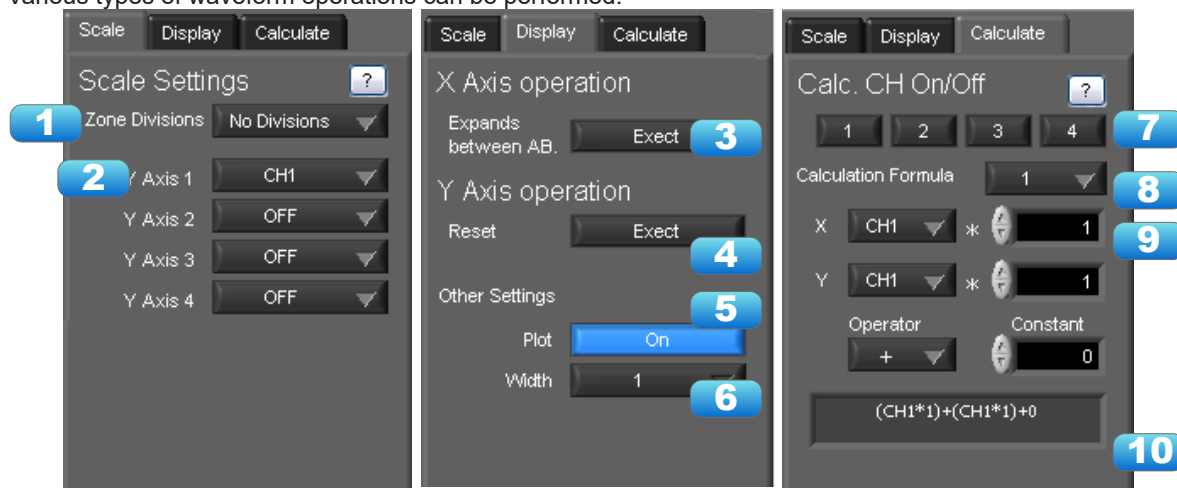

No.	Name	Description
Scale		
1	Zone Divisions	Divide the Y-T waveform graph into the upper side and the lower side. (No Divisions/2 Divisions/5 Divisions/10 Divisions)
2	Y Axis	When "Zone Divisions" is set to "No Divisions", up to four Y axis ranges can be displayed.
Display		

3	Expands between A-B	Expands data between Cursors A and B when the scroll is stopped during capture, or during replay. * The expansion in the Y-axis direction is not available.
4	Y Axis Operation Reset	Click this button to revert the values set in the Y axis span and position to the default values. The default values are the same values as those of when switching the ranges.
5	Plot	Click this button to display plot marks at the actual sample points on the waveforms.
6	Line Width	Change the line width of the waveforms.(1/2/3/4/5) * The line may be thicker than the selected number of dots due to circumstances regarding input signals.
Calculation		
7	Calculation CH On/Off	Use these buttons to set calculations 1-4 to On/Off. On : Calculation results are shown as waveforms and digital values. Off : Do not perform calculations.The calculation results are only shown in Y-T display, and do not affect the captured data.
8	Calculation channel X/Y	Sets the calculation channel for which calculation is to be set (* The unit conforms to CH X.)
9	Calculation Formula	Use this button to set the variable for a linear expression between channels. $A \cdot CH X + B \cdot CH Y + C$ The expression you set appears at the bottom of this window. (A and B are arbitrary coefficients. * is an arithmetic operation (+-x+). X and Y are arbitrary channels, and C is an arbitrary constant.)
10	Expression	Displays the calculation specified in the Expression setting.

*CH between the operation of the GL device is not synchronized.

7-15-2-2. Input Comments

Click this icon to input a comment above the waveform of the desired channel during a data capture (replay) operation. If the scroll is ON, the input position is at the "Comment Input" in the upper part of a waveform. If the scroll is OFF, it is the position of Cursor A.

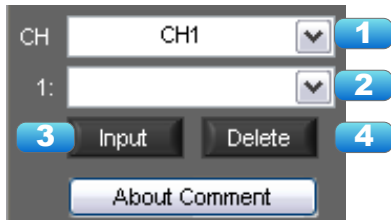

No.	Name	Description
1	CH	Select a channel for entering a comment.
2	Comment input/select	Enters a comment. Up to 20 comments can be entered. If you change a position where a comment has already been entered, the entered comment will also be changed.
3	Input	Click this button to input the comment..
4	Delete	Click this button to delete the comment that was input

● CHECKPOINT

Comments will be displayed based on the scale specified at the start of the data capture operation.If the Y-axis scale is changed during data capture, the input comments will be off positioned when displayed on the replay screen. To display the comments above the waveform, change the Y-axis scale after the replay.

7-15-2-3. Move/Search

During replay, cursor A and the waveforms can be moved to the desired position. You select how to move them and perform the operation with the "Move" tab.



No.	Name	Description
Search		
1	CH	Use this button to select the CH to be searched.
2	Slope	Use this button to select the slope to use for performing the search. H : Search for a rising signal. L : Search for a falling signal.
3	Level	Use this button to set the search level.
4	Prev./Next Search	Performs analog search. The judgment criteria of search is an edge. • Find Previous: Search in the past direction • Find Next: Search in the future direction
5	Search List	Ver. 1.10 and later versions Executes an analog search and displays a list of results.
6	Alarm	This parameter is used to specify the alarm port number.
7	Generated/Cleared	Use this button to set the alarm status in which searches are performed. Generated : Performs search when an alarm is generated. Cleared : Performs search when an alarm is cleared.
8	Prev./Next Search	Performs alarm search. The judgment criteria of search is an edge. • Find Previous: Search in the past direction • Find Next: Search in the future direction
Move		
9	CH	Use this button to select the CH to be moved.
10	Search Max/Min	Searches for the maximum and minimum values of the specified channel. • Find Maximum: Searches for the maximum value. • Find Minimum: Searches for the minimum value.
11	Search in absolute time	Search the specified time/date. * This function is not available for external sampling data.
12	Search in relative time	Search the specified time. The searched time is the relative time from when data capture was started. * This function is not available for external sampling data.

7-15-2-4. Search List

Executes an analog search and displays a list of results.

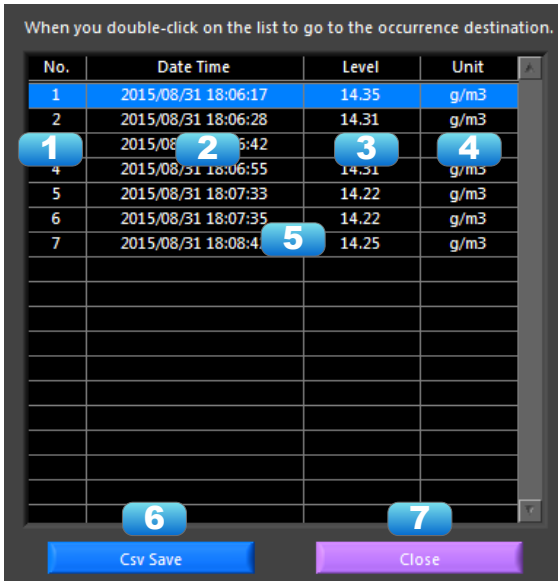

No.	Name	Description
1	No.	The number found in the search.
2	Date Time	The time of the data found in the search.
3	Level	The value of the level of the data found in the search.
4	Unit	The unit of the data found in the search.
5	Double-Click Transport	Double-clicking on a list found in the search will move to the location where cursor A has been found on the waveform display screen.
6	CSV Save	Outputs the list found in the search in the form of a CSV file.
7	Close	Closes the window.

Example of CSV Output Results

	A	B	C	D	E	F
1	Vendor	Graphtec Corporation				
2	Model	GL28-APS				
3	Version	1				
4						
5	Created	2023/5/16	11:18			
6	File Name	GL840_01_2023-05-16_11-41-39.gbd				
7						
8	CH	HD weariness				
9	Mode	Upper				
10	Level	13 g/m3				
11						
12	No.	Date	Time	ms	Level	Unit
13	1	2023/5/16	8:03:14	400	13.02	g/m3
14	2	2023/5/16	8:03:15	400	13.02	g/m3
15	3	2023/5/16	8:55:36	400	13	g/m3
16	4	2023/5/16	9:04:16	400	13.09	g/m3
17	5	2023/5/16	9:05:02	400	13.05	g/m3
18	6	2023/5/16	9:05:14	400	13.02	g/m3
19	7	2023/5/16	9:06:34	400	13.02	g/m3
20	8	2023/5/16	9:11:35	800	13.08	g/m3

GRAPHTEC

- Specifications are subject to change without notice.

GL28 Application Software User's Manual
APS(GL28)-UM-153 1st edition
July 1, 2026

GRAPTEC IWATSU Test Instruments Co.,Ltd.
